



| BASIC 2

Product catalogue

CONTENT

- This is how you use Basic 2 7
- Components 8**
 - Uprights 9
 - Feet 10
 - Wall fitting 10
 - Plinths and metal shelves 11
 - End frame solutions 12
 - Extensions 13
 - Upright for wall fixing 13
 - Back solution – panel plan 14
 - Back solution – panel perfex 15
 - Back solution – slat walls 16
 - Bottom frames 17
 - Friezes 17
 - Corner components 18
 - Back panel plane – for corners 19
 - Back panel perfex (perforated) – for corners 20
 - Corner covers 20
 - Spacers 21
- Shelves 24**
 - Sheet shelves 25
 - Wire shelves 27
 - Sheet shelves perforated 30
 - Glass shelves 31
 - Frame with shelves 32
 - Wooden shelves 33
 - Shelves for magazines 34
 - Other shelves 35
 - Shelves for corners 37
- Accessories 40**
 - Rail for hooks 41
 - Rail for hooks – heavy load 43
 - Rail for garden tools 44
 - Accessories for perforated back panels 44
 - Accessories for slat walls 47
 - Price tags 48
 - Glass show case 49
 - Price rails 49
 - Accessories for upselling sales 50
- Compositions wall 52**
 - Back solution – panel plan 53
 - Back solution – panel perfex 57
- Compositions floor 61**
 - Floor solution – panel plan 62
 - Floor solution – panel perfex 65
- Wall 68**
- Colours & materials 77**
- Installation manuals / Load survey 82**



WANZL NORDIC

your local business partner and one-stop-shop within retail and store solutions

■ **Wanzl Nordic is a Nordic developer and manufacturer of store solutions.** We are dedicated to the store. We assist our customers in attracting attention, ripening purchase decisions and creating sales. And we have more than 60 years of experience in everything from design of fashion and specialty shops to supermarkets.

Wanzl Nordic can be with you all the way from development and production to roll-out. And we can deliver to the local market or follow the ambitions of our customers into the world. Our main office is located in Denmark, and we have

subsidiaries in Norway, Sweden and Finland. Wanzl Nordic employs approx. 330 people, and annual sales amount to slightly above DKK 500 million. We are a part of the German Wanzl Group, who is represented in most of the world.

What you have here is Wanzl Nordic’s catalogue of our standard system, The Basic 2 standard shelving system is one among several systems in Wanzl Nordic’s assortment.

If you have questions regarding the brochure, the system or Wanzl Nordic, please just call us – +45 87 612 200.

Wanzl Nordic reserves the right to any changes in content without notice.

- We do not assume responsibility for any printing or other errors in the catalogue
 - We reserve the right to make changes in the products, the assortment and specifications without notice
 - Previously published product specifications are hereby rendered invalid

Solution cycle HOW WE ROLL

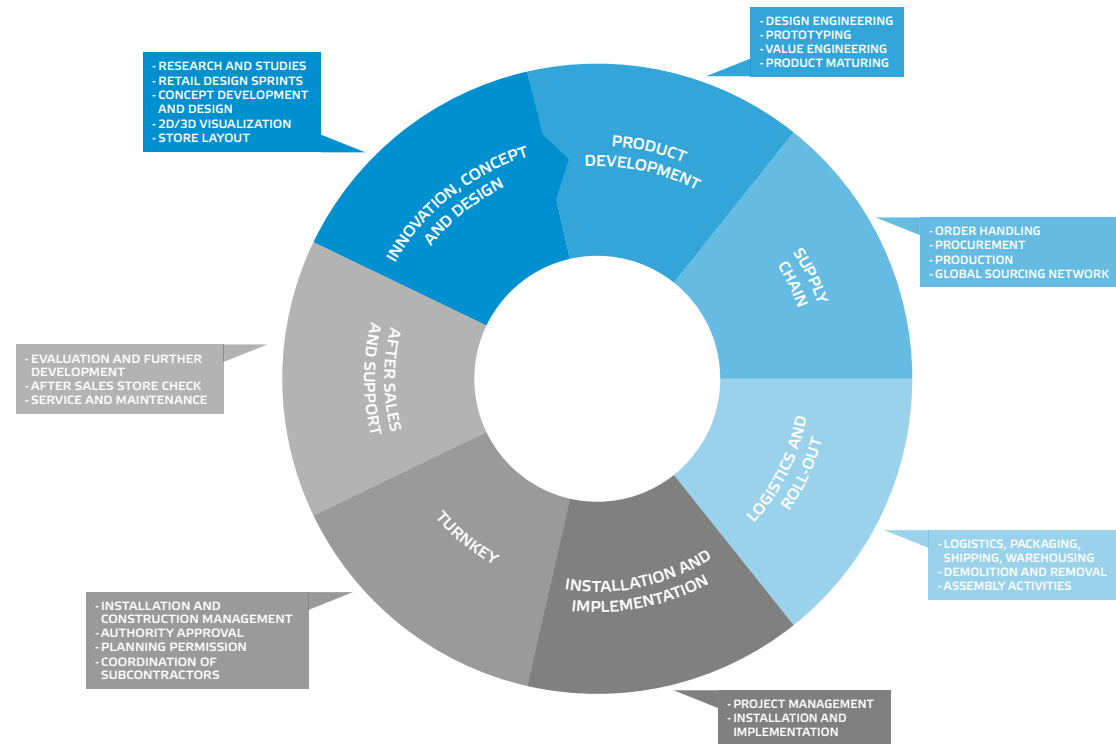

Competences

If you choose Wanzl Nordic as your shop fitting partner you will open a well-assorted tool box. Due to the fact that Wanzl Nordic has divided the process into minor steps from the time that the idea has been captured and concretised until the time of a completed shop, we provide the possibility for the customer for selecting the tools necessary for the project concerned. This concerns development, project design or implementation – or all three stages.

I WE ARE HERE TO SOLVE YOUR TASK

– not to sell you as much as possible

We can supply everything from turnkey retail to shop-in-shops and displays. And you, of course, decide which services you need. Some use us for professional discussions and shop design, others as an efficient manufacturer or an experienced roll-out partner.

Shopfitting

Wanzl Nordic has a large and well-proven standard range of shopfitting, as a supplement to the individually designed solutions. Various shop and warehouse systems featuring infinite combination possibilities and finishing degrees, so that it is also here possible to create an individual expression. We are moreover capable of supplying a wide range of shopping trolleys, shopping baskets, entrance systems, check-outs and various transport solutions.

Specialists

Your solution is best created by like-minded people. Therefore Wanzl Nordic is divided into three teams, each dedicated to their own special field within shopfitting for the retail sector: Fashion & Lifestyle, Specialist Trade and Food Retail. You will therefore always receive skilled counselling from Wanzl Nordic tailored to your market and your daily life.

Development

If, for example, you want to change your position in the market, adjust to a new target group or optimize your costs, Wanzl Nordic can devise a process of development which will ensure that you reach your targets. From counselling and shop design to prototype and test. All the time in close dialogue with your organization so that all aspects are considered in the final solution.

Production and sourcing

Wanzl Nordic has its own wood and metal production as well as a comprehensive network of carefully selected international sub-suppliers. This creates maximum flexibility for you as a customer. In all manufacturing we choose the optimum production solution based on your needs. Which means that reaction time, price, delivery and quality is all tailored to your needs as a customer. We also source production from remote markets – like China.

Execution/roll-out

ROI is not generated until your store solution is complete, with goods on the shelves. And then it will hopefully work for many years. Wanzl Nordic therefore offers an efficient shop roll-out set-up. Logistics and warehousing, installation and setting-up, service and replacement. As well as continuous upgrading, so that your solution is always up-to-date.

| ONE SYSTEM, MANY FACES

■ When using Basic 2, you will get a presentable, profile creating, flexible and customer-friendly store design, which at the same time is easy to handle for the employees in the store.

The Basic 2 system offers numerous possibilities of combination and makes up the optimum basic shopfitting solution for virtually all sectors. Whether grocery stores, garden centres, hardware shops, book stores, radio/TV shops or something entirely different, Basic 2 will meet the demands for attractive and well-arranged presentation, which contributes to creating the profile and expression of the store.

The Basic 2 shopfitting will also enable you to underline the overall concept of the chain and set focus on seasonal-, campaign- and incentive sales. The system includes several decoration effects making it possible to establish targeted sales, while at the same time achieving high-profiling of the store.

Moreover, the Basic 2 system offers a variety of accessories as well as varying column heights, foot depths and module measurements, which increase the flexibility.

Should you need special components, we also manufacture such.

| THIS IS HOW YOU USE BASIC 2



A few words regarding basic 2

Basic 2 is a flexible and functional shop fitting system, and all details have been brought into focus. The system is easy to handle, has loose feet, can be supplied with different back panel solutions and consist of basic modules in 60 or

90 cm for wall or floor as well as wall uprights for presentation of lightweight items.

Besides, we have a comprehensive range of accessories.

I COMPONENTS

In this chapter we focus on the basic components that Basic2 consists of: Uprights, feet, locks, back panels etc.

I COMPONENTS

Basic 2 can be supplied as standard modules of 90 cm. The columns are equipped with a slotting distance of only 32 mm which provides effective adjusting of capacity and utilisation of space. The back panels can easily be exchanged for differentiated exposure of articles and profiling purposes.

The system is supplied with loose feet minimising the shipment expenses and handling. Moreover, the system is simple and easy to assemble in the shop minimising the time consumption in connection with establishment and re-construction. Special components will be manufactured according to demands.

UPRIGHTS

UPRIGHTS 60X30 MM

054-6030-3	126H
054-6031-3	142H
054-6032-3	158H
054-6033-3	180H
054-6034-3	212H
054-6035-3	228H
054-6036-3	235H
054-6037-3	267H
054-6038-3	299H

It is recommended to use wall fittings. See next page.

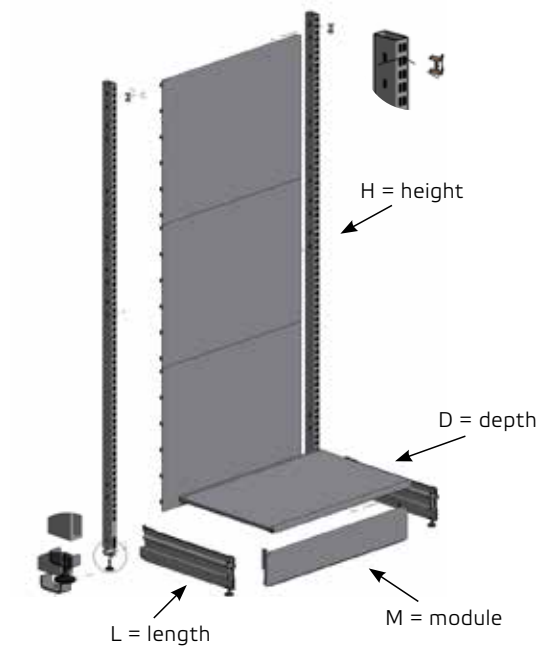

UPRIGHTS 80X30 MM

054-8030-3	126H
054-8031-3	142H
054-8032-3	158H
054-8033-3	180H
054-8034-3	212H
054-8035-3	228H
054-8036-3	235H
054-8037-3	267H
054-8038-3	299H

It is recommended to use wall fittings. See next page.

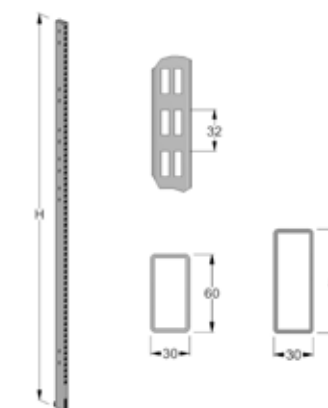

FEET



LOCK FOR FOOT 60X30

022-4020-4

LOCK FOR FOOT 80X30

022-4040-4

BASE FOOT

022-4000-3	26L	(for 30D shelf)
022-4001-3	36L	(for 40D shelf)
022-4002-3	46L	(for 50D shelf)
022-4003-3	56L	(for 60D shelf)
022-4005	66L	(for 70D shelf)
022-4004-3	76L	(for 80D shelf)

Bottom plate shelf = depth of foot + 4 cm.

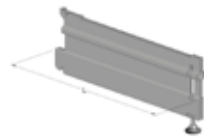

FOOT EXTENSION

022-2326-3	10L
022-2325-3	20L

See photo at last page in the chapter.



WALL FIXING BRACKETS

WALL FIXING – START

016-2215-0

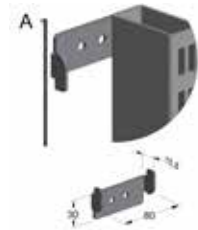

WALL FIXING – FOLLOW

016-2216-0

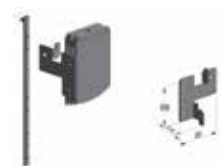

WALL FIXING BRACKET UNIVERSAL

016-0683-0

Break-off function for easy adjustment to depths from 60-350 mm.



PLINTHS AND METAL SHELVES

PLINTH

022-4090-3	90M
022-4060-3	60M

PLINTH REINFORCED

022-4121-3	90M
022-4122-3	60M



PLINTH GABLE – RIGHT & LEFT

022-0196-3	46L
022-0228-3	56L

Used as cover plate on foot.



PLINTH BACK

022-1328-3	90M
022-1338-3	60M

Cover at the back of freestanding compositions.

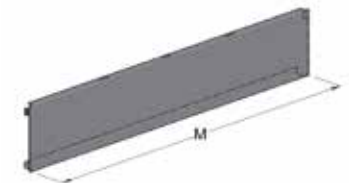

SHEET METAL SHELF

014-6730-3	90M	30D
014-6740-3	90M	40D
014-6750-3	90M	50D
014-6760-3	90M	60D
014-6770-3	90M	70D
014-6780-3	90M	80D



014-6530-3	60M	30D
014-6540-3	60M	40D
014-6550-3	60M	50D
014-6560-3	60M	60D
014-6580-3	60M	80D

SHEET METAL SHELF REINFORCED

014-3532-3	90M	50D
014-6968-3	90M	60D
014-6969-3	60M	60D

END FRAME SOLUTIONS

END FRAME FOR 60X30 UPRIGHT

017-0025-3	126H	90M
017-0027-3	142H	90M
017-0026-3	158H	90M
017-6029-3	180H	90M
017-6028-3	212H	90M
017-0307-3	228H	90M
017-1228-3	267H	90M

END FRAME FOR 80X30 UPRIGHT

017-1195-3	142H	90M
017-1190-3	158H	90M
017-1191-3	180H	90M
017-1192-3	212H	90M

COMPOSITION

TOP COVER FOR ENDFRAME 60X30 UPRIGHT

015-1026-3	126H	90M
------------	------	-----

TOPCOVER FOR ENDFRAME 80X30 UPRIGHT

015-1027-3	126H	90M
------------	------	-----

TOP COVER FOR END FRAME WITH SIGN FRAME

015-0077-3		90M
------------	--	-----

For 60x30 upright

EXTENSIONS

EXTENSION FOR 60X30 UPRIGHT

054-2258-3	54H
054-2297-3	70H
054-0519-3	140H
054-2318-3	163H

EXTENSION FOR 80X30 UPRIGHT

054-6107-3	70H
------------	-----

COMPOSITION

UPRIGHT FOR WALL FIXING

WALL UPRIGHT

054-0001-3	180H
054-0002-3	219H
054-0747-3	264H
054-3096-3	295H

COMPOSITION

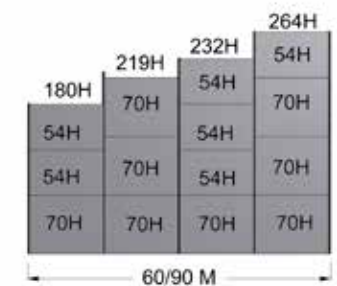
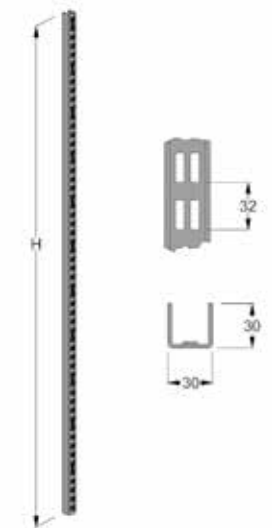
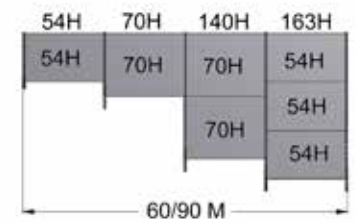
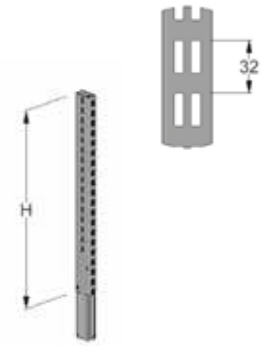
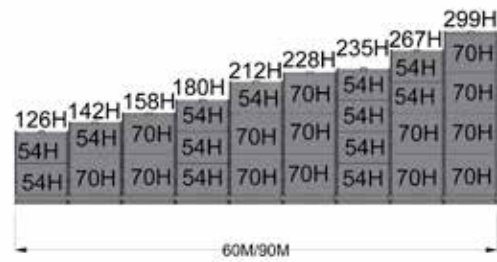

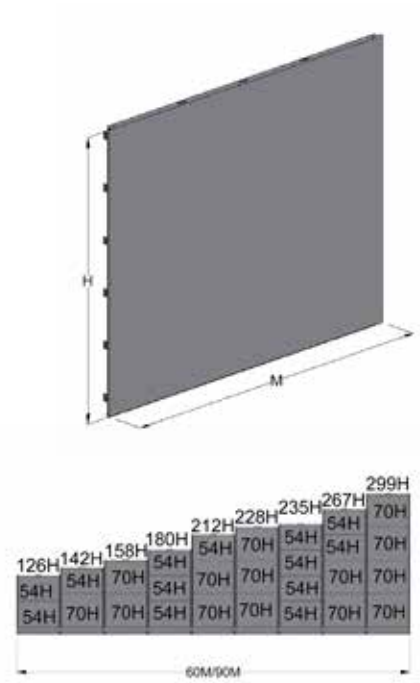

BACK PANEL PLANE

BACK PANELS PLANE

019-7902-3	54H	90M
019-7904-3	70H	90M
019-7602-3	54H	60M
019-7604-3	70H	60M

COMPOSITION

For composition of back panels in combination with uprights for wall fixing.

BACK PANEL LOCKING CLIP

012-7207-0

Must always be used with setting without distance brackets. Installation manual on page 84-89.

TOP COVER FOR 60X30 UPRIGHT

015-1005-3	90M
015-1025-3	60M

TOP COVER FOR 80X30 UPRIGHT

015-1024-3	90M
015-1023-3	60M

TOP COVER FOR 60X30 UPRIGHT

015-0040-3	90M
------------	-----

TOP COVER WITH INFO SIGN FOR 60X30 UPRIGHT

BSC098	90M
--------	-----

See photo at last page in the chapter.



BACK PANEL PERFEX (PERFORATED)

PANEL PERFEX

025-5042-3	54H	90M
025-5024-3	70H	90M
025-5013-3	54H	60M
025-5014-3	70H	60M

COMPOSITION

For composition of back panels in combination with uprights for wall fixing.

BACK PANEL LOCKING CLIP

012-7207-0

Must always be used with setting without distance brackets. Installation manual on page 84-89.

TOP COVER FOR 60X30 UPRIGHT

015-1005-3	90M
015-1025-3	60M

TOP COVER FOR 80X30 UPRIGHT

015-1024-3	90M
015-1023-3	60M

TOP COVER WITH INFO SIGN FOR 60X30 UPRIGHT

015-0040-3	90M
------------	-----

TOP COVER WITH INFO SIGN FOR 60X30 UPRIGHT

BSC098	90M
--------	-----

See photo at last page in the chapter.

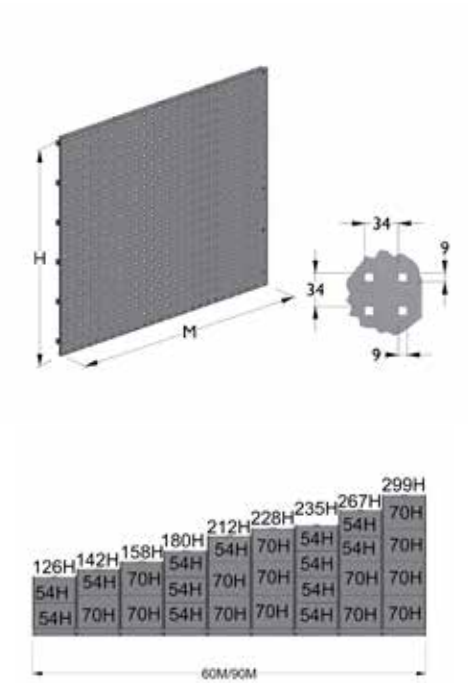

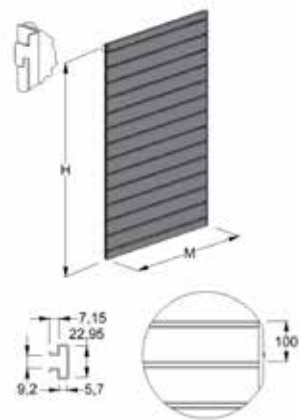

BACK PANEL SLAT WALL

BACK PANEL – SLATT WALL

019-6159-3	142H	90M
019-6160-3	158H	90M
019-6161-3	228H	90M

Melamin U 164 PE anthrazit grey.
Other surfaces on request.

FENDER

056-5811-0	90M
056-5812-0	60M
056-5809-3	90M*

*For strengthend sheet shelf 014-6968-3.
See photo at last page in the chapter.

END FOR FENDER

080-5404-4	Right
080-5405-4	Left

Must be pop rivet on fender.

HEAVY DUTY EXTENTION

BSC096	140H	60D
--------	------	-----

COMPONENTS

05405013	Front upright 50L 128H
05405033	Front upright 60L 128H
02400573	Upright 25H
02150203	Bracket connective 50L
02150063	Bracket connective 57L
00230484	Wire shelf 90M 60D

See photo at last page in the chapter.

SHELF BOX

014-3013-3	90M	50D
014-3331-3	90M	60D

BOTTOM FRAMES

BOTTOM FRAMES WITH WHEELS – START

007-2210-3	90M	50D
------------	-----	-----

BOTTOM FRAMES WITH WHEELS – FOLLOW

007-2211-3	90M	50D
------------	-----	-----

DRAWER WITH WHEELS

014-1890-3	90M	On depth from 46 cm
014-1860-3	60M	On depth from 46 cm

See photo at last page in the chapter.



FRIEZES

CANOPY FRIEZE WALL

022-1907-3	90M
023-0450-3	60M

Only to be used on top of the upright.

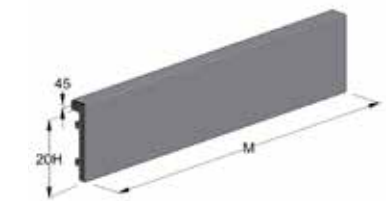

PANEL FRIEZE

022-1950-3	90M
022-1975-3	60M

Can be mouted on all existing back panel solutions.

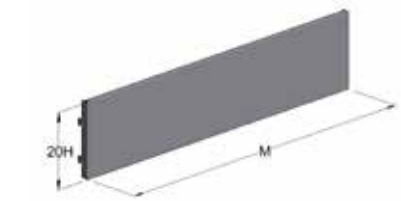

PANEL FRIEZE

022-2301-3	90M
022-2300-3	60M

Can be mounted on all existing back panel solutions.

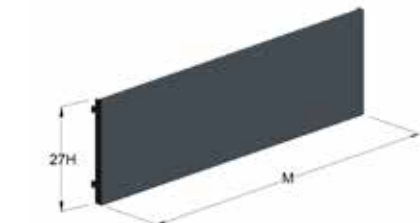

PANEL FRIEZE

022-2335-3	90M
022-2336-3	60M

Can be mounted on all existing back panel solutions.

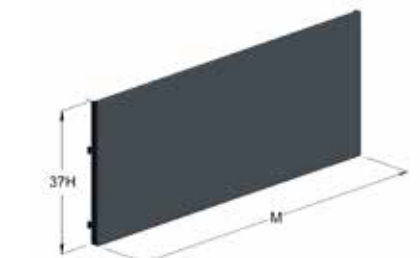

CORNER COMPONENTS

PLINTH INTERNAL CORNER FOR 60X30 UPRIGHT

022-9040-3	26L
022-9041-3	36L
022-9042-3	46L
022-9043-3	56L
022-9044-3	76L

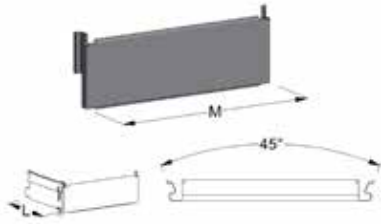

PLINTH INTERNAL CORNER FOR 80X30 UPRIGHT

022-9045-3	26L
022-9046-3	36L
022-9047-3	46L
022-9048-3	56L
022-9049-3	76L

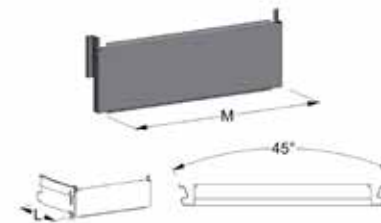

PLINTH EXTERIOR CORNER – 60X30 UPRIGHT

022-9070-3	90M	60D ¹⁾
022-9073-3	90M	40D ²⁾
022-9080-3	90M	50D ³⁾

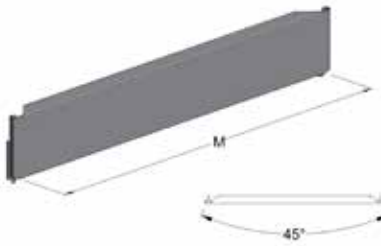

- 1) For sheet shelf 014-5249-3.
- 2) For sheet shelf 014-5264-3.
- 3) For sheet shelf 014-5252-3.

SHEETSHELF FOR INTERNAL CORNER FOR 60X30 UPRIGHT

014-5243-3	30D
014-5244-3	40D
014-5245-3	50D
014-5246-3	60D
014-5248-3	80D

See examples on page 68-76.

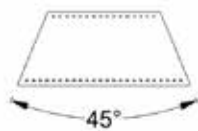

SHEETSHELF FOR EXTERIOR CORNER FOR 80X30 UPRIGHT

014-0400-3	30D
014-0401-3	40D
014-0402-3	50D
014-0403-3	60D
014-0404-3	80D

See examples on page 68-76.

SHEETSHELF FOR EXTERIOR CORNER FOR 60X30 UPRIGHT

014-5264-3	40D
014-5252-3	50D
014-5249-3	60D

See examples on page 68-76.

SHEETSHELF FOR EXTERIOR CORNER FOR 80X30 UPRIGHT

014-5265-3	40D
014-5266-3	50D
014-5267-3	60D

See examples on page 68-76.

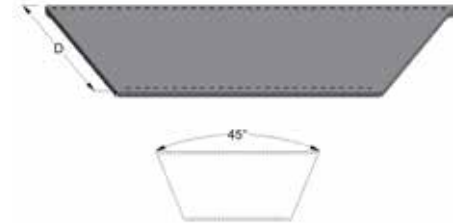

BACK PANEL PLANE – FOR CORNERS

PANEL PLANE FOR INTERNAL CORNER FOR 60X30 UPRIGHT

019-7700-3	54H
019-7701-3	70H

PANEL PLANE FOR INTERNAL CORNER FOR 80X30 UPRIGHT

019-7740-3	54H
019-7741-3	70H

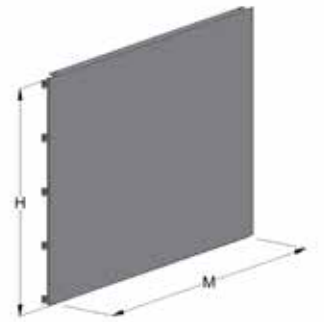

PANEL PLANE FOR EXTERIOR CORNER FOR 60X30 UPRIGHT

019-7938-3	54H
019-7937-3	70H

PANEL PLANE FOR EXTERIOR CORNER FOR 80X30 UPRIGHT

019-7947-3	54H
025-1080-3	70H

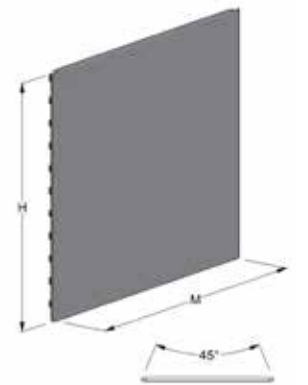

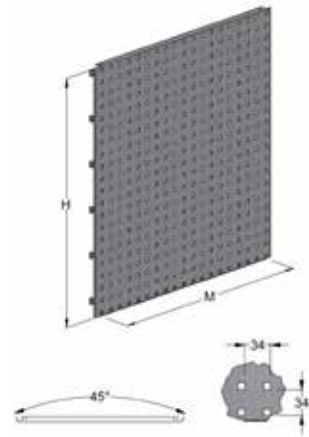

BACK PANEL PERFEX (PERFORATED) – FOR CORNERS

PANEL PERFEX INTERNAL CORNER FOR 60X30 UPRIGHT

025-5044-3	54H
025-5045-3	70H

PANEL PERFEX INTERNAL CORNER FOR 80X30 UPRIGHT

025-5138-3	54H
025-5139-3	70H

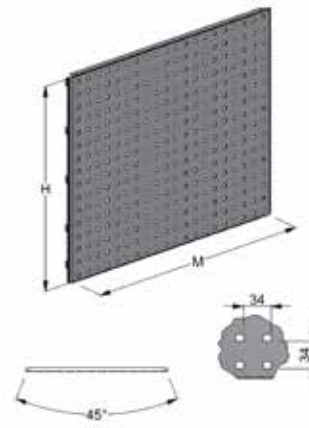

PANEL PERFEX FOR 45 DEGREES EXTERIOR CORNER FOR 80X30 UPRIGHT

025-5115-3	54H
025-5124-3	70H

PANEL PERFEX FOR 45 DEGREES EXTERIOR CORNER FOR 80X30 UPRIGHT

025-5135-3	54H
025-5136-3	70H

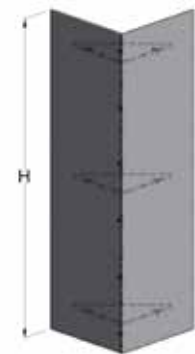

CORNER COVERS

CORNER COVER

027-1437-0	70D	234H
------------	-----	------

Melamine grey U112 PE.
Fits for upright 228H and shelf 60D.
Can be customized to depth on foot by assembly.

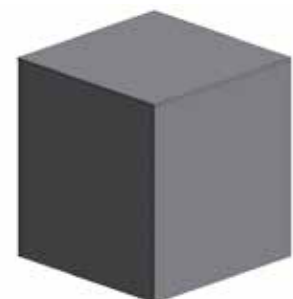

CORNER COVER

027-0873-0	126D	141H
------------	------	------

Melamine grey U112 PE.
See photo at last page in the chapter.

SPACERS

SPACER

022-0398-3	90M
022-0397-3	60M

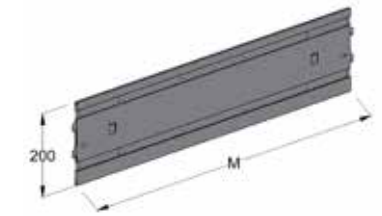

SPACER

022-0404-3	90M
022-0724-3	60M



SPACER

022-0251-3	90M
022-0050-3	60M

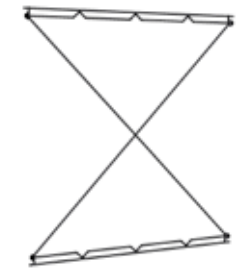

SPACER

024-0441-3	90M
024-0442-3	60M



Components

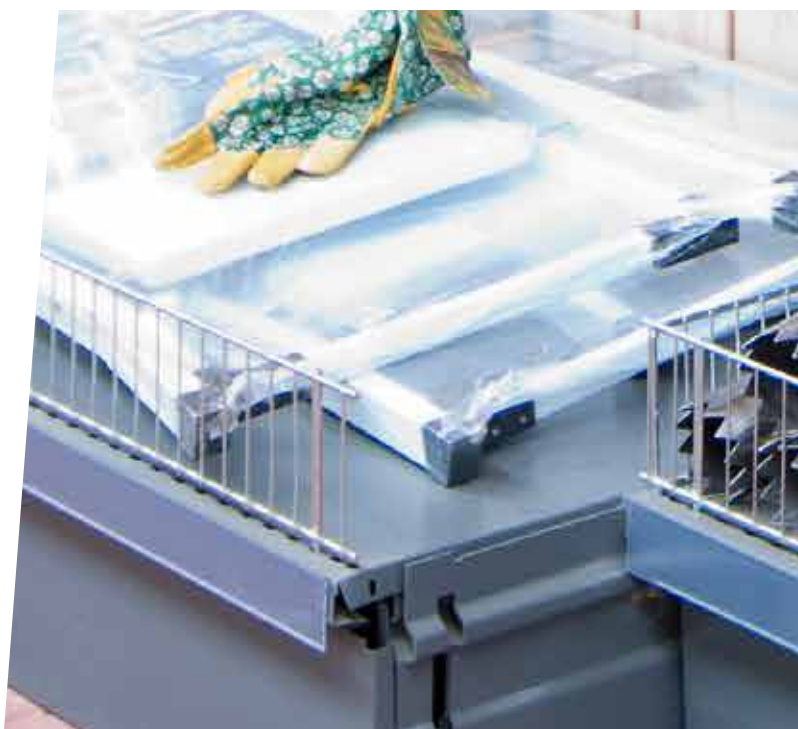
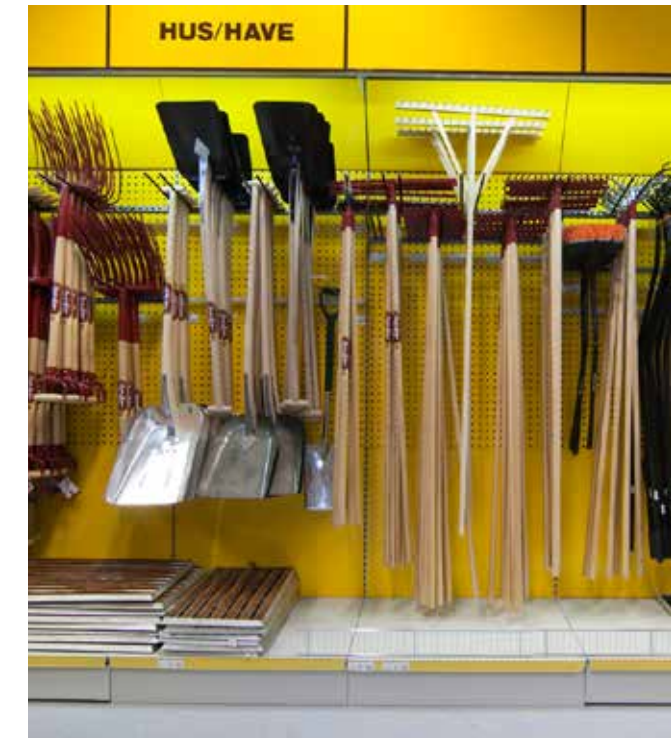

I SHELVES

Different shelves allow you to present your products in the best possible way. For a varied presentation, we provide standard width steel, wire wood, glass and canopy shelves.

SHEET METAL SHELVES

SHEET METAL SHELF 90M

014-6720-3	90M	20D
014-6730-3	90M	30D
014-6740-3	90M	40D
014-6745-3	90M	45D
014-6750-3	90M	50D
014-6760-3	90M	60D
014-6770-3	90M	70D
014-6780-3	90M	80D

Extra strengthened:

014-6968-3	90M	60D
------------	-----	-----

SHEET METAL SHELF 60M

014-6520-3	60M	20D
014-6530-3	60M	30D
014-6540-3	60M	40D
014-6545-3	60M	45D
014-6550-3	60M	50D
014-6560-3	60M	60D
014-6570-3	60M	70D
014-6580-3	60M	80D

Extra strengthened:

014-6969-3	60M	60D
------------	-----	-----

DIVIDER

006-6612-4	30L	10H
006-6615-4	40L	10H
006-6617-4	50L	10H
006-6619-4	60L	10H
006-6621-4	80L	10H

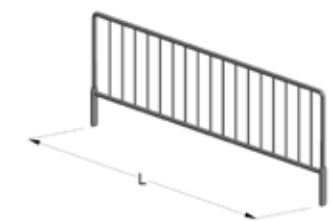
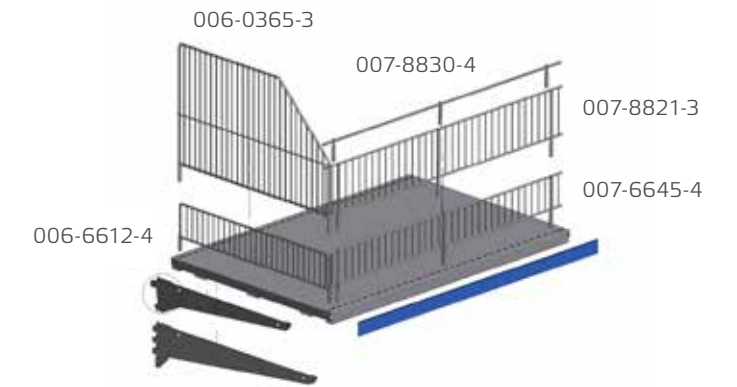

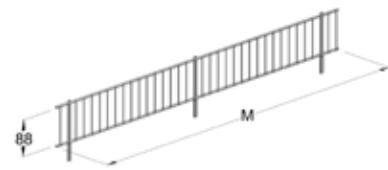

FRONT RAISER

007-6645-4	90M	10H
007-6642-4	90M	10H

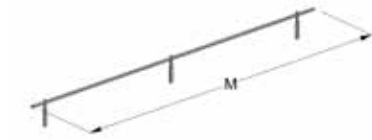

FRONT RAISER FOR PRICERAIL

007-8830-4	90M
007-8831-4	60M

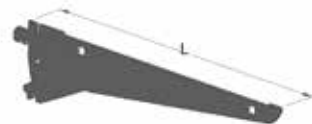

BRACKET ADJUSTABLE

021-2980-3	20L
021-2982-3	30L
021-2984-3	40L
021-2986-3	50L*)
021-2988-3	60L*)



*) Not recommended for heavy goods. Use a straight bracket.

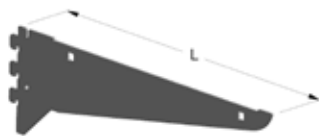

BRACKET STRAIGHT

021-4752-3	30L
021-4754-3	40L
021-4756-3	50L
021-4758-3	60L

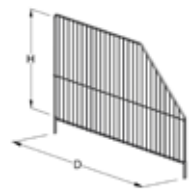

END GRID

006-0363-3	50D
006-0365-3	60D

For 007-8821-3.

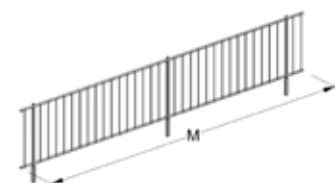

FRONT RAISER

007-8821-3	14H
------------	-----

For 006-0365-3.

WIRE SHELVES

WIRE SHELF 90M

002-3000-3	90M	20D
002-3001-3	90M	25D
002-3042-3	90M	30D
002-3003-3	90M	35D
002-3044-3	90M	40D
002-3045-3	90M	45D
002-3506-3	90M	50D
002-3006-3	90M	50D *)
002-3048-3	90M	60D
002-3008-3	90M	60D*)

*) Heavy duty. For use in areas with heavy loading.

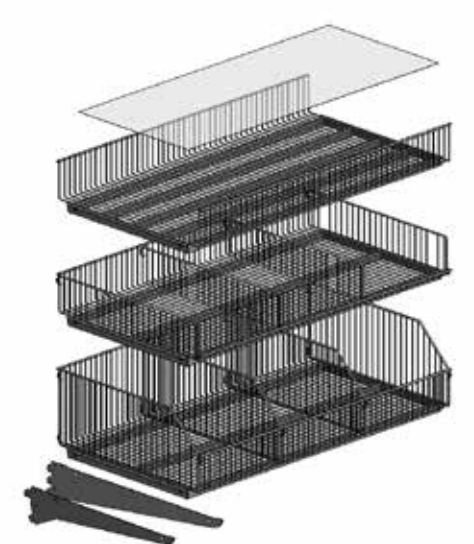

WIRE SHELF 60M

002-3901-3	60M	25D
002-3902-3	60M	30D
002-3903-3	60M	35D
002-3904-3	60M	40D
002-3905-3	60M	45D
002-3906-3	60M	50D
002-3908-3	60M	60D

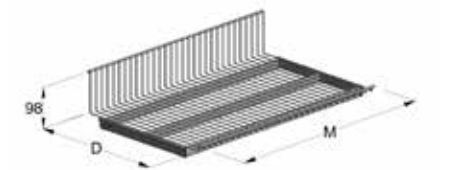

WIRE SHELF WITH HIGH FRONTEDGE

002-3074-3	90M	30D
002-3061-3	90M	40D
002-3030-3	90M	50D
002-3069-3	60M	30D
002-3071-3	60M	40D
002-3072-3	60M	50D

DIVIDER 10H

006-0100-3		20D
006-0101-3		25D
006-0102-3		30D
006-0103-3		35D
006-0104-3		40D
006-0105-3		45D
006-0106-3		50D
006-0108-3		60D

WIRE SHELF WITH LOW BACKEDGE

002-3007-3	90M	20D
002-3009-3	90M	30D
002-3011-3	90M	40D
002-3037-3	60M	20D
002-3013-3	60M	30D
002-3014-3	60M	40D

DIVIDER 5H

006-2101-3	90M	20D
006-2102-3	90M	30D
006-3314-3	90M	40D

WIRE SHELF WITH 20 CM BACKEDGE

001-0190-3	90M	50D
------------	-----	-----

DIVIDER 20H

006-0246-3		50D
------------	--	-----

BRACKET ADJUSTABLE

021-2980-3		20L
021-2981-3		25L
021-2982-3		30L
021-2983-3		35L
021-2984-3		40L
021-2985-3		45L
021-2986-3		50L*)
021-2988-3		60L*)

*) Not recommended for heavy goods.
Use a straight bracket.

BRACKET STRAIGHT

021-4752-3		30L
021-4753-3		35L
021-4754-3		40L
021-4755-3		45L
021-4756-3		50L
021-4758-3		60L

PLASTIC COVER PLATE

017-2016-0	90M	30L
017-2028-0	90M	35L
017-2013-0	90M	40L
017-2029-0	90M	45L
017-2019-0	90M	50L

WIRE SHELF FOR PRESENTATION

002-3252-3	90M	80D
------------	-----	-----

Not recommended for heavy goods.

BRACKET FOR PRESENTATION

021-0491-3		80L
------------	--	-----

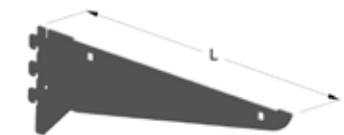
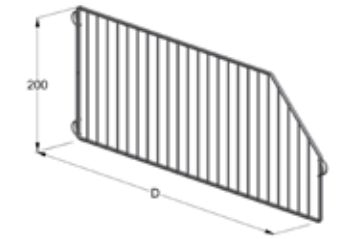
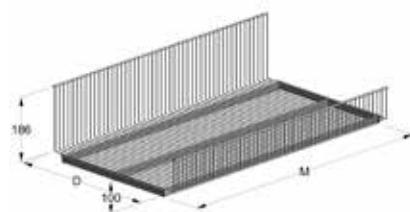
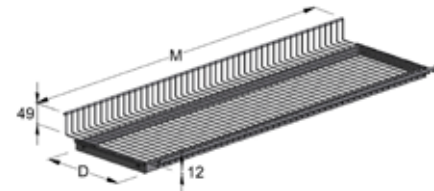



SHEET METAL SHELVES PERFORATED

WIRE SHELF 90M

014-5307-3	90M	30D
014-5302-3	90M	40D
014-5300-3	90M	45D
014-5299-3	90M	50D
014-5303-3	90M	60D
014-5390-3	60M	30D
014-5298-3	60M	45D
014-5393-3	60M	50D

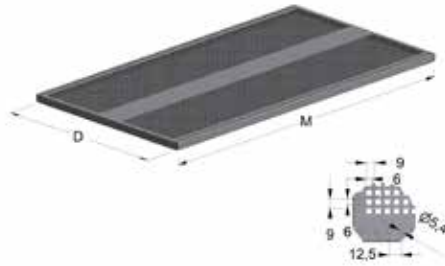

BRACKET ADJUSTABLE

021-2982-3	30L
021-2984-3	40L
021-2985-3	45L
021-2986-3	50L *)
021-2988-3	60L*)



*) Not recommended for heavy goods.
Use a straight bracket.

BRACKET STRAIGHT

021-4752-3	30L
021-4754-3	40L
021-4755-3	45L
021-4756-3	50L
021-4758-3	60L

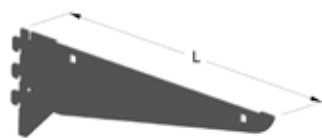

FRONT RAISER

007-8810-3	10H	90M
007-8860-3	10H	60M

Only fits on shelves with round holes in the front.

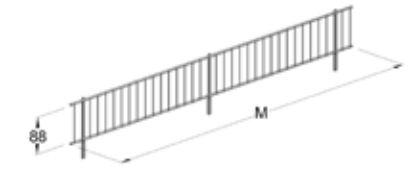

DIVIDER SHEET SHELF

006-8802-3	30L
006-8804-3	40L
006-8805-3	45L
006-8806-3	50L
006-8808-3	60L

Only fits on shelves with round holes in the front.

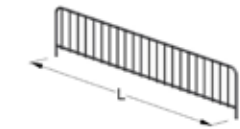

GLASS SHELVES

GLASS SHELF WITH BRACKETS

BSC081	90M	30D
BSC083	90M	40D
BSC081-60	60M	30D
BSC083-60	60M	40D



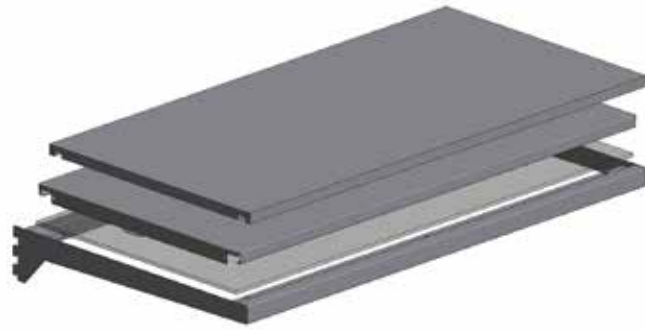

FRAME WITH SHELVES

FRAME FOR SHELF

014-1466-3	90M	40D
014-3273-3	90M	50D



SHEET SHELF FOR FRAME

014-1466-3	90M	40D
014-1467-3	90M	50D



GLASS SHELF FOR FRAME

014-1470-0	90M	40D
014-1469-0	90M	50D

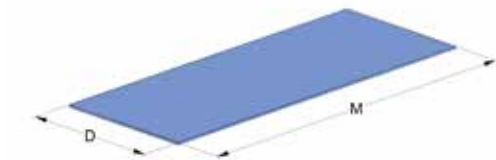

WOOD SHELF FOR FRAME

014-1474-0	90M	40D *)
014-1471-0	90M	50D *)

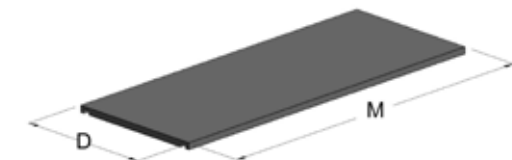

*) Melamine U 164 PE anthrazit grey.

WOODEN SHELVES

FRAME FOR SHELF

019-6173-0	90M	40D
019-6175-0	90M	50D
019-6176-0	60M	40D
019-6178-0	60M	50D

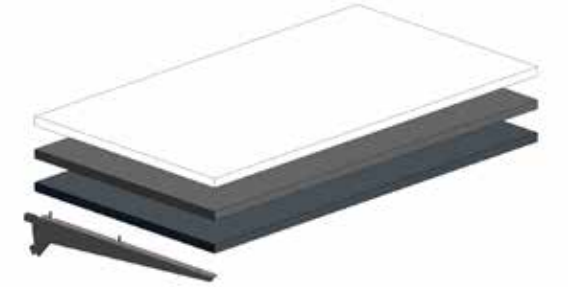

WOODEN SHELF MELAMINE U112 PE GREY

019-6170-0	90M	40D
019-6172-0	90M	50D
019-6171-0	60M	40D
019-6174-0	60M	50D

WOODEN SHELF MELAMINE K101 WHITE

019-6179-0	90M	40D
019-6181-0	90M	50D
019-6182-0	60M	40D
019-6184-0	60M	50D

Other surfaces on request.



BRACKET ADJUSTABLE

080-7987-3	30L	Left
080-7988-3	30L	Right
080-7991-3	40L	Left
080-7992-3	40L	Right
080-7995-3	50L	Left
080-7996-3	50L	Right
082-3666-3	60L	Left
082-3667-3	60L	Right

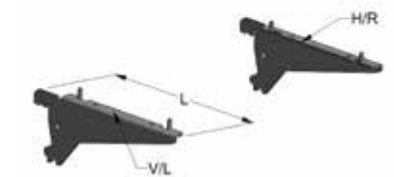

END SHELF U112 PE GREY

027-2252-3	90M	40D
------------	-----	-----

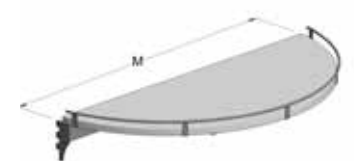

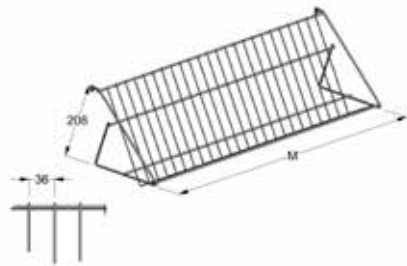
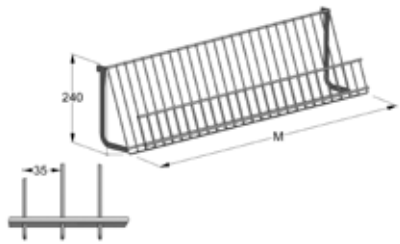
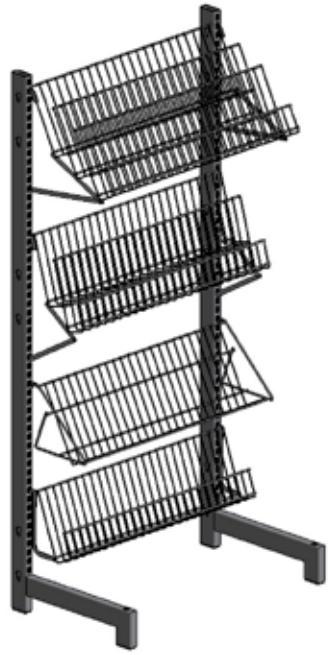

SHELVES FOR MAGAZINES

WIRE SHELF MAGAZINES

017-0259-3 90M

WIRE SHELF MAGAZINES 90M

017-0253-4 90M

See photo at last page in the chapter.

OTHER SHELVES

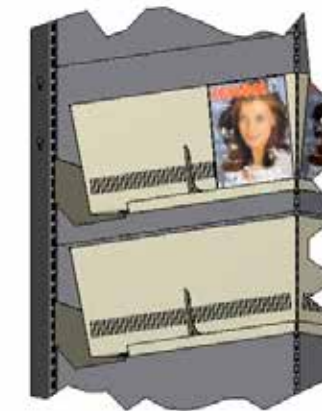
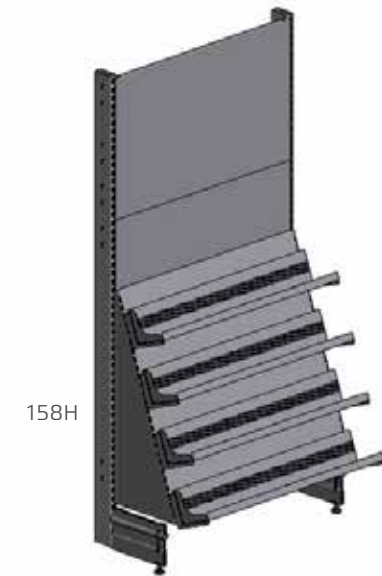
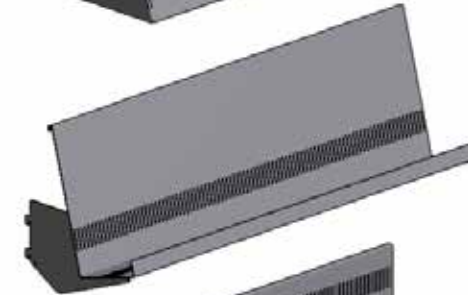
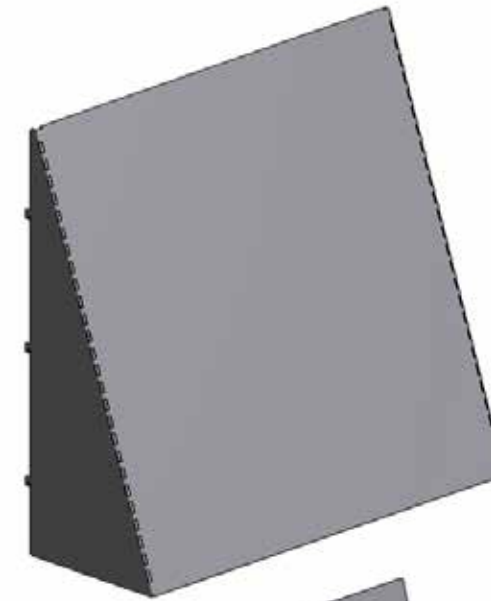



BOTTOM SHELF SLOPING

014-1203-3	90M
------------	-----



SHEET SHELF

014-1071-3	90M	14D
------------	-----	-----

Max 4 shelves per bottom shelf sloping.

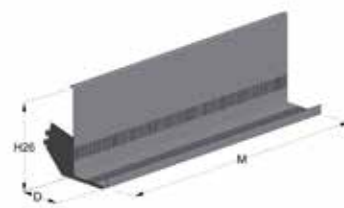

SHEET SHELF FOR MAGAZINES AND PAPERBACKS

014-1070-3	90M	14D
------------	-----	-----

Max 3 shelves per bottom shelf sloping.

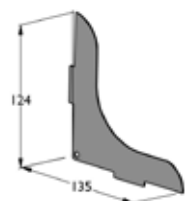

DIVIDER

006-0976-3

SHELVES FOR CORNERS

SHEET SHELF FOR INTERNAL CORNER FOR 60X30 UPRIGHT

014-5243-3	30D
014-5244-3	40D
014-5245-3	50D
014-5246-3	60D
014-5248-3	80D

SHEET SHELF FOR INTERNAL CORNER FOR 80X30 UPRIGHT

014-0400-3	30D
014-0401-3	40D
014-0402-3	50D
014-0403-3	60D
014-0404-3	80D

FRONT RAISER FOR PRICERAIL 450

007-8832-4

SHEET SHELF FOR EXTERNAL CORNER FOR 60X30 UPRIGHT

014-5264-3	40D
014-5252-3	50D
014-5249-3	60D

SHEET SHELF FOR EXTERNAL CORNER FOR 80X30 UPRIGHT

014-5265-3	40D
014-5266-3	50D
014-5267-3	60D



Shelves



WIRE SHELF FOR INTERNAL CORNER FOR 60X30 UPRIGHT

001-7644-3	30D
001-7645-3	45D
001-7646-3	50D
001-7649-3	60D

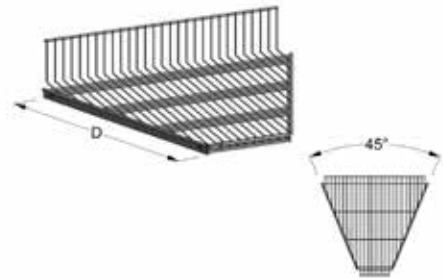

WIRE SHELF FOR INTERNAL CORNER FOR 80X30 UPRIGHT

001-7654-3	30D
001-7655-3	45D
001-7656-3	50D
001-7650-3	60D



WIRE SHELF FOR EXTERIOR CORNER FOR 60X30 UPRIGHT

002-3112-3	30D
002-3100-3	45D
002-3113-3	50D
002-3114-3	60D

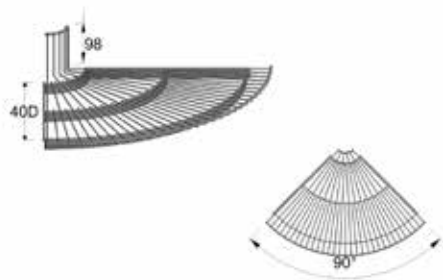

WIRE SHELF FOR EXTERIOR CORNER FOR 80X30 UPRIGHT

002-3115-3	30D
002-3101-3	45D
002-3116-3	50D
002-3117-3	60D





ACCESSORIES – RAILS AND HOOKS

FLAT RAIL

016-6800-4	90M		Zinc
016-6793-4	60M		Zinc
25x6 mm steel			



COAT HANGER RAIL

016-3020-4	90M	30D	Zinc
016-3021-4	60M	30D	Zinc
016-0593-4	90M	40D	Zinc
016-0594-4	90M	50D	Zinc
25x6 mm steel			



HOOK RAIL INTERNAL CORNER

016-4200-4			Zinc
25x6 mm steel			

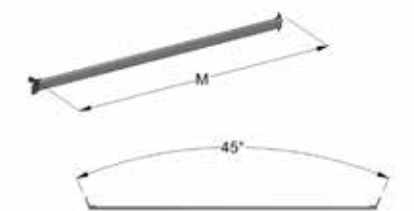

SINGLE HOOK WITH PLASTIC COVERED TIP

016-8400-4	Ø5,0 mm	5L	Zinc
016-8401-4	Ø5,0 mm	11L	Zinc
016-8402-4	Ø5,0 mm	15L	Zinc
016-8403-4	Ø5,0 mm	20L	Zinc
016-8404-4	Ø5,0 mm	25L	Zinc
016-8405-4	Ø5,0 mm	30L	Zinc



I ACCESSORIES

In this chapter you will find hooks for presentation of small products, e.g. products creating additional sales.



SINGLE HOOK WITH PRICE TAG HOLDER WITH FIXING BRACKET

016-1173-4	Ø4,8 mm	20L	Zinc
016-1971-4	Ø4,8 mm	30L	Zinc



SINGLE HOOK

016-2544-0	Ø4,8 mm	15L	Zinc
016-2594-4	Ø4,8 mm	20L	Zinc



DOUBLE HOOK

016-2273-4	Ø4,8 mm	15L	Zinc
------------	---------	-----	------



SINGLE HOOK WITH CLAW FIXING

016-9783-4	Ø8,0 mm	30L	Zinc
------------	---------	-----	------



SINGLE HOOK WITH CLAW FIXING

016-9759-4	Ø4,0 mm	12L	Zinc
016-9760-4	Ø4,8 MM	20L	Zinc
016-9761-4	Ø4,8 MM	30L	Zinc



HOOK FOR SHOES WITH CLAW FIXING

016-0036-4	Ø8,0 mm	30L	Zinc
016-9785-4	Ø8,0 MM	40L	Zinc

HOOK ADJUSTABLE FOR PRICE RAILS

016-0070-4	12L	Zinc
016-0071-4	20L	Zinc
016-0072-4	30L	Zinc



2 LEVEL TEXTILE HANGER

016-6700-4	20+20L	Zinc
------------	--------	------

See photo on last page of section.



TEXTILE HANGER INCLINED

016-4020-4	40L	Zinc
------------	-----	------



FRONT HANGER

016-4664-4	30L	Zinc
------------	-----	------



RAIL FOR HOOKS HEAVY LOAD

RAIL FOR HOOKS HEAVY LOAD

016-8517-4	90M	Zinc
60x17 mm profile		



HOOK SINGLE FOR HEAVY LOAD

016-3332-4	Ø8,0 mm	20L	Zinc
016-3334-4	Ø8,0 mm	30L	Zinc

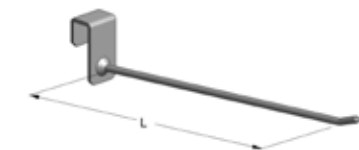

RAIL FOR GARDEN TOOLS

DETAIL0030	90M	Powder coated
Incl. 6 stk. straight hooks		Rubber coated
25x25 mm profile		

PRICE TAG ADAPTOR

016-9695-0	Ø12 mm	White plastic
Fits straight hooks		

HOOK FOR RAIL (SPARE PART)

016-0015-5	Ø10,0 mm	35L	Rubber coated
------------	----------	-----	---------------

SINGLE HOOK FOR RAIL FOR TOOLS

016-3345-4	Ø6,0 mm	30L	Zinc
------------	---------	-----	------

ACCESSORIES FOR PERFEX BACK PANELS

All hooks fits 9x9 mm square holes with 34x34 mm cc and panel thickness of 1,25 mm.

SINGLE HOOK WITH PLASTIC FIXING

016-9809-4	Ø4,8 mm	5L	Zinc
016-9801-4	Ø4,8 mm	10L	Zinc
016-9802-4	Ø4,8 mm	15L	Zinc
016-9803-4	Ø5,0 mm	20L	Zinc
016-9804-4	Ø5,0 mm	25L	Zinc
016-9805-4	Ø5,0 mm	30L	Zinc

See photo on last page of section.

T HOOK FOR PRICE RAIL WITH PLASTIC FIXING

016-4684-4	Ø5,0 mm	10L	Zinc
016-4683-4	Ø5,0 mm	15L	Zinc
016-4681-4	Ø5,0 mm	20L	Zinc
016-4680-4	Ø5,0 mm	30L	Zinc
016-4695-4	Ø5,0 mm	40L	Zinc

SINGLE HOOK WITH 4 TAP FIXING BRACKET

016-9950-4	Ø4,8 mm	10L	Zinc
016-9946-4	Ø6,0 mm	20L	Zinc
016-9958-4	Ø6,0 mm	25L	Zinc
016-9947-4	Ø6,0 mm	30L	Zinc
016-9998-4	Ø6,0 mm	40L	Zinc

HOLDER FOR PRICE RAIL WITH 4 TAP FIXING BRACKET

017-2908-4	Ø6,0 mm	20L	Zinc
017-2909-4	Ø6,0 mm	30L	Zinc
017-3143-4	Ø6,0 mm	40L	Zinc

SECURITY FITTING

016-7158-0

SINGLE HOOK WITH PRICE TAG HOLDER WITH 4 TAP FIXING BRACKET

016-1177-4	Ø4,8 mm	10L	Zinc
016-1173-4	Ø6,0 mm	20L	Zinc
016-0556-0	Ø6,0 mm	30L	Zinc

DOUBLE HOOK WITH 4 TAP FIXING BRACKET

016-9989-4	Ø4,8 mm	10L	Zinc
016-9948-4	Ø4,8 mm	20L	Zinc
016-9949-4	Ø4,8 mm	30L	Zinc
016-9939-4	Ø6,0 mm	40L	Zinc





DOUBLE HOOK WITH HOLDER FOR PRICE TAG WITH 4 TAP FIXING BRACKET

016-1175-4	Ø4,8 mm	20L	Zinc
016-1176-4	Ø4,8 mm	30L	Zinc



DIVIDER

006-0213-3		24D	Powder coated
006-0271-3		37D	Powder coated

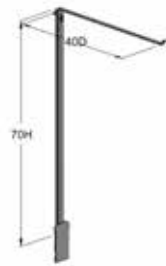

POSTER FRAME HOLDER FOR 60 X 30 UPRIGHT

012-0228-3			Powder coated
------------	--	--	---------------



HOOK FOR TOOLS Ø6 WITH BLACK RIBBED RUBBER

016-2127-0			
------------	--	--	--

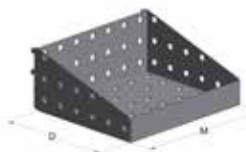

PERFORATED METAL SHELF HIGH

017-1710-3	24M	30D	Powder coated
017-2193-3	24M	20D	Powder coated

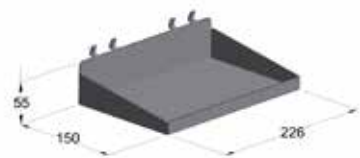

METAL SHELF LOW

014-1745-3	24M	15D	Powder coated
------------	-----	-----	---------------



METAL BASKET

EXP020	25M	15D	Zinc
--------	-----	-----	------

ACCESSORIES FOR SLATWALLS

Fits Wanzl Nordic slatwalls.

SINGLE HOOK WITH RUBBER COVERED TIP

016-9793-4	Ø4,8 mm	5L	Zinc
016-9799-4	Ø4,8 mm	12L	Zinc
016-9800-4	Ø4,8 mm	20L	Zinc

See photo on last page of section.



SINGLE HOOK

016-2248-4		10L	Zinc
------------	--	-----	------



SINGLE HOOK WITH HOLDE FOR PRICE RAIL

016-2121-4	Ø4,0 mm	10L	Zinc
------------	---------	-----	------



DOUBLE HOOK WITH HOLDER FOR PRICE RAIL

016-9955-4	Ø4,0 mm	20L	Zinc
------------	---------	-----	------



METAL SHELF WITH 15 MM HIGH EDGE

014-1221-3	20M	14D	Powder coated
014-1230-3	30M	14D	Powder coated



METAL SHELF FOR SHOES

016-1100-3	30M	30D	Powder coated
------------	-----	-----	---------------

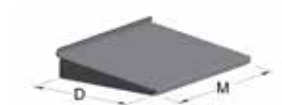



POSTER FRAME A4 WITH ACRYLIC FRONT

BSC127	A4	Powder coated
--------	----	---------------



BROCHURE POCKET A4 WITH ACRYLIC FRONT

BSC126	A4	Powder coated
--------	----	---------------



ANGLED SHELF FOR BROCHURES

017-4485-3	A4
------------	----



SHELF FOR BROCHURES

017-4486-3	85M	30D
------------	-----	-----



METAL BASKET

EXP007	25M	15D	Zinc
--------	-----	-----	------



ADAPTORS AND PRICE TAGS

ADAPTOR PLASTIC

016-2228-0	Ø4,8 mm	White plastic
016-9685-28	Ø5,0 mm	White plastic
016-9700-0	Ø6,0 mm	White plastic
016-9688-0	Ø8,0 mm	White plastic
017-0459-0	Ø10,0 mm	White plastic
016-9695-0	Ø12,0 mm	White plastic

PRICE TAG METAL

017-0461-0	Ø4,8 mm	27 x 27 mm	Stainless
018-0027-0		27 x 32 mm	Metal



PRICE TAG

018-0108-0	Ø4,8 mm	39 x 52 mm	Transparent
018-0134-0	Ø4,8 mm	39 x 75 mm	Transparent



GLASS SHOW CASE

WITH SLIDING GLASS DOORS AND LED LIGHT AND TWO SHELVES

BSC008-1	90M
BSC009-1	90M

Comes with metal rear panel.

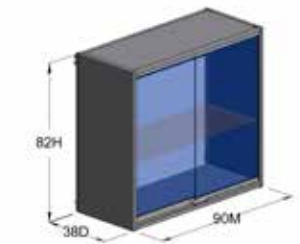

PRICE RAILS

PRICE RAIL FOR SHEET METAL SHELVES

018-0201-0	90M	3,9H	Transparent - adhesive
013-0171-0	90M	3,9H	Grey - adhesive
018-0301-0	90M	2,6H	Transparent - adhesive
018-0200-0	60M	3,9H	Transparent - adhesive

Grey - adhesive = RAL 7015.

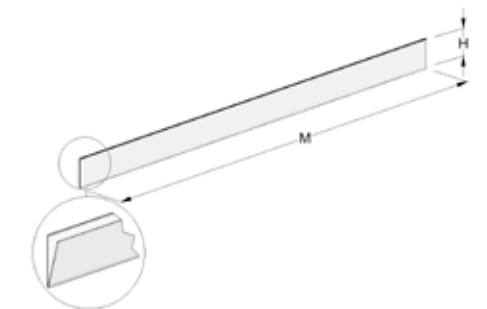

PRICE RAIL FOR WIRE SHELF

018-0211-0	90M	3,9H	Transparent
018-0210-0	60M	3,9H	Transparent
013-0170-0	90M	3,9H	Grey ral 7015
018-0311-0	90M	2,6H	Transparent
018-0310-0	60M	2,6H	Transparent

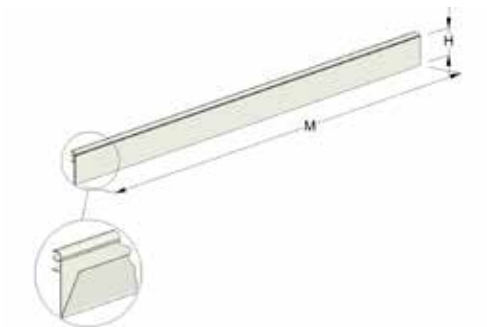



ACCESSORIES FOR UPSELLING

BASKET FOR WIRE SHELF

EXP002	27M	17D
--------	-----	-----



FISHBONE

016-0465-4	130H
------------	------

Price tag can be mounted.



HANGER WITH FOOT

012-1308-3	135H
------------	------

Price tag can be mounted.



HOOK FOR WIRE SHELF

016-3402-3	15L
------------	-----

Accessories



I BACK PANEL PLANE

Intro for panel plane system

Wall and floor system with smooth steel backpanel. The backpanel closes off the background and is available in numerous colours, which contributes to supporting the expression and profile of the store. Can be installed with for example hook rails and brackets for shelves mounting.

Facts:

- Available in numerous colours
- Mounted at the front of the column
- Can be installed with hook rails and brackets

The following examples are all based on a 60x30 upright.

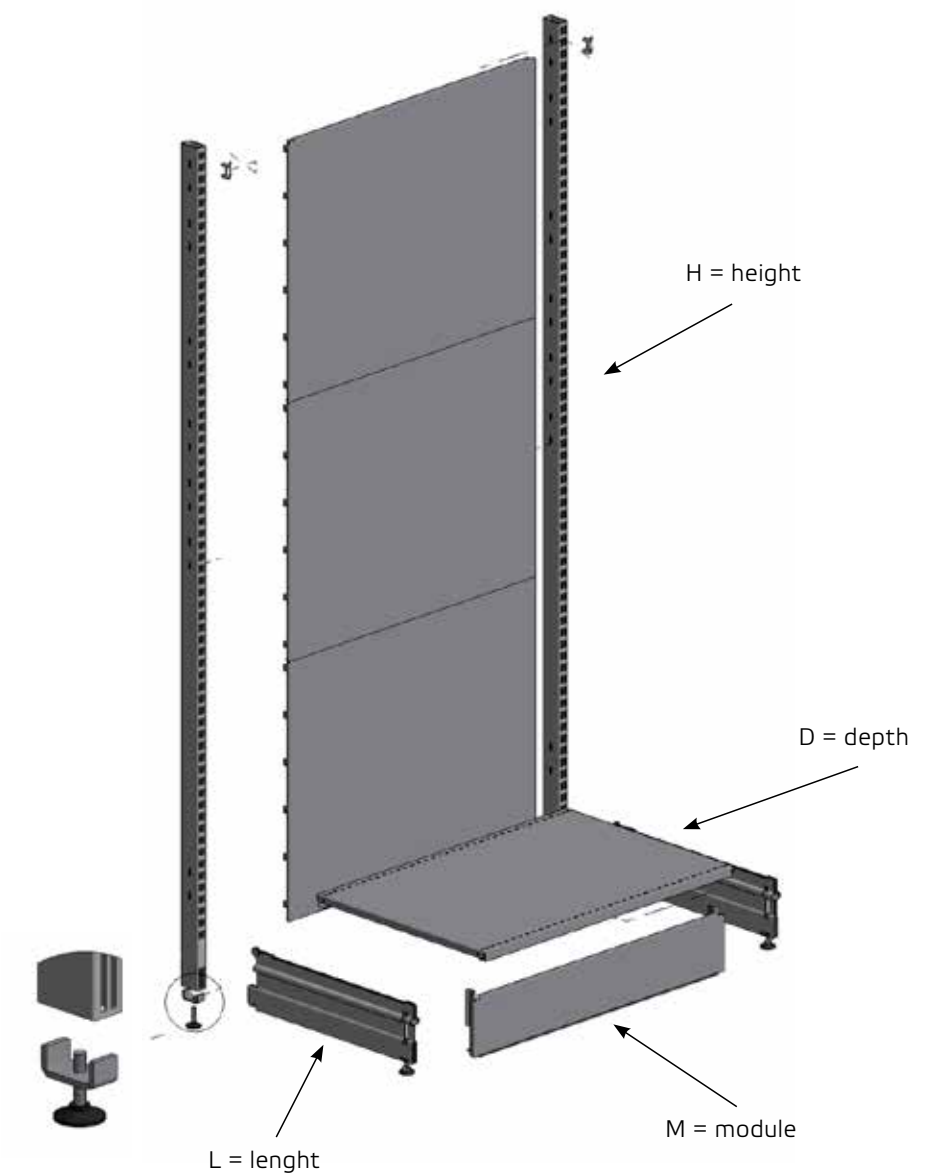

I COMPOSITIONS WALL

In the following chapter, you find the different compositions for wall mount and their product numbers.

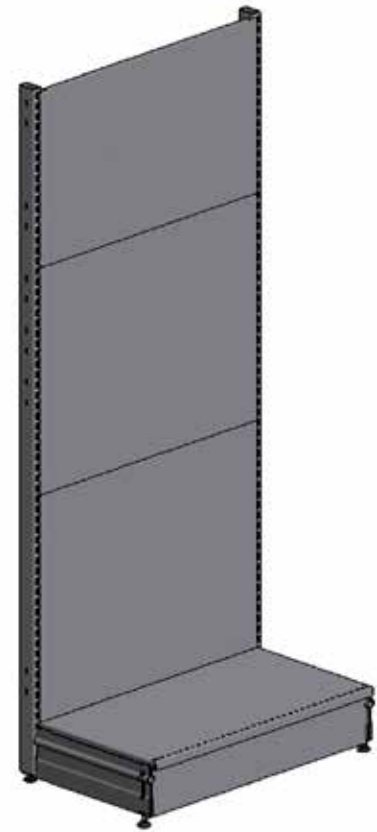

WALL SECTION START 50D

BSC2-6-180-2-13	180H	90M	50D
BSC2-6-212-2-13	212H	90M	50D
BSC2-6-228-2-13	228H	90M	50D
BSC2-6-235-2-13	235H	90M	50D
BSC2-6-267-2-13	267H	90M	50D
BSC2-6-299-2-13	299H	90M	50D

BSC2-6-180-2-136	180H	60M	50D
BSC2-6-212-2-136	212H	60M	50D
BSC2-6-228-2-136	228H	60M	50D
BSC2-6-235-2-136	235H	60M	50D
BSC2-6-267-2-136	267H	60M	50D
BSC2-6-299-2-136	299H	60M	50D

WALL SECTION START 60D

BSC2-6-180-2-03	180H	90M	60D
BSC2-6-212-2-03	212H	90M	60D
BSC2-6-228-2-03	228H	90M	60D
BSC2-6-235-2-03	235H	90M	60D
BSC2-6-267-2-03	267H	90M	60D
BSC2-6-299-2-03	299H	90M	60D

BSC2-6-180-2-036	180H	60M	60D
BSC2-6-212-2-036	212H	60M	60D
BSC2-6-228-2-036	228H	60M	60D
BSC2-6-235-2-036	235H	60M	60D
BSC2-6-267-2-036	267H	60M	60D
BSC2-6-299-2-036	299H	60M	60D

WALL SECTION FOLLOW 50D

BSC2-6-180-2-14	180H	90M	50D
BSC2-6-212-2-14	212H	90M	50D
BSC2-6-228-2-14	228H	90M	50D
BSC2-6-235-2-14	235H	90M	50D
BSC2-6-267-2-14	267H	90M	50D
BSC2-6-299-2-14	299H	90M	50D

BSC2-6-180-2-146	180H	60M	50D
BSC2-6-212-2-146	212H	60M	50D
BSC2-6-228-2-146	228H	60M	50D
BSC2-6-235-2-146	235H	60M	50D
BSC2-6-267-2-146	267H	60M	50D
BSC2-6-299-2-146	299H	60M	50D

WALL SECTION FOLLOW 60D

BSC2-6-180-2-04	180H	90M	60D
BSC2-6-212-2-04	212H	90M	60D
BSC2-6-228-2-04	228H	90M	60D
BSC2-6-235-2-04	235H	90M	60D
BSC2-6-267-2-04	267H	90M	60D
BSC2-6-299-2-04	299H	90M	60D

BSC2-6-180-2-046	180H	60M	60D
BSC2-6-212-2-046	212H	60M	60D
BSC2-6-228-2-046	228H	60M	60D
BSC2-6-235-2-046	235H	60M	60D
BSC2-6-267-2-046	267H	60M	60D
BSC2-6-299-2-046	299H	60M	60D

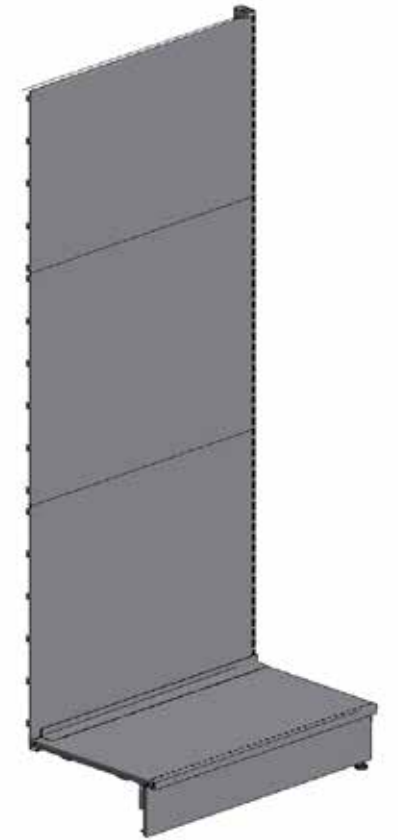

BACK PANEL PERFEX



WALL SECTION CORNER 50D

BSC2-6-180-2-16	180H	90M	50D
BSC2-6-212-2-16	212H	90M	50D
BSC2-6-228-2-16	228H	90M	50D
BSC2-6-235-2-16	235H	90M	50D
BSC2-6-267-2-16	267H	90M	50D
BSC2-6-299-2-16	299H	90M	50D

WALL SECTION CORNER 60D

BSC2-6-180-2-06	180H	90M	60D
BSC2-6-212-2-06	212H	90M	60D
BSC2-6-228-2-06	228H	90M	60D
BSC2-6-235-2-06	235H	90M	60D
BSC2-6-267-2-06	267H	90M	60D
BSC2-6-299-2-06	299H	90M	60D

Intro for panel perfex system

Wall and floor system with perforated backpanel provides a variety of options for mounting og hooks and sales-promoting products. The backpanel closes off the background and is available in numerous colours, which contributes to supporting the expression and profie og the store.

Facts:

- Optimal for mounting og hooks and sales promoting products
- Available in numerous colours
- Mounted at the front og the column

The following examples are all based on a 60x30 upright.

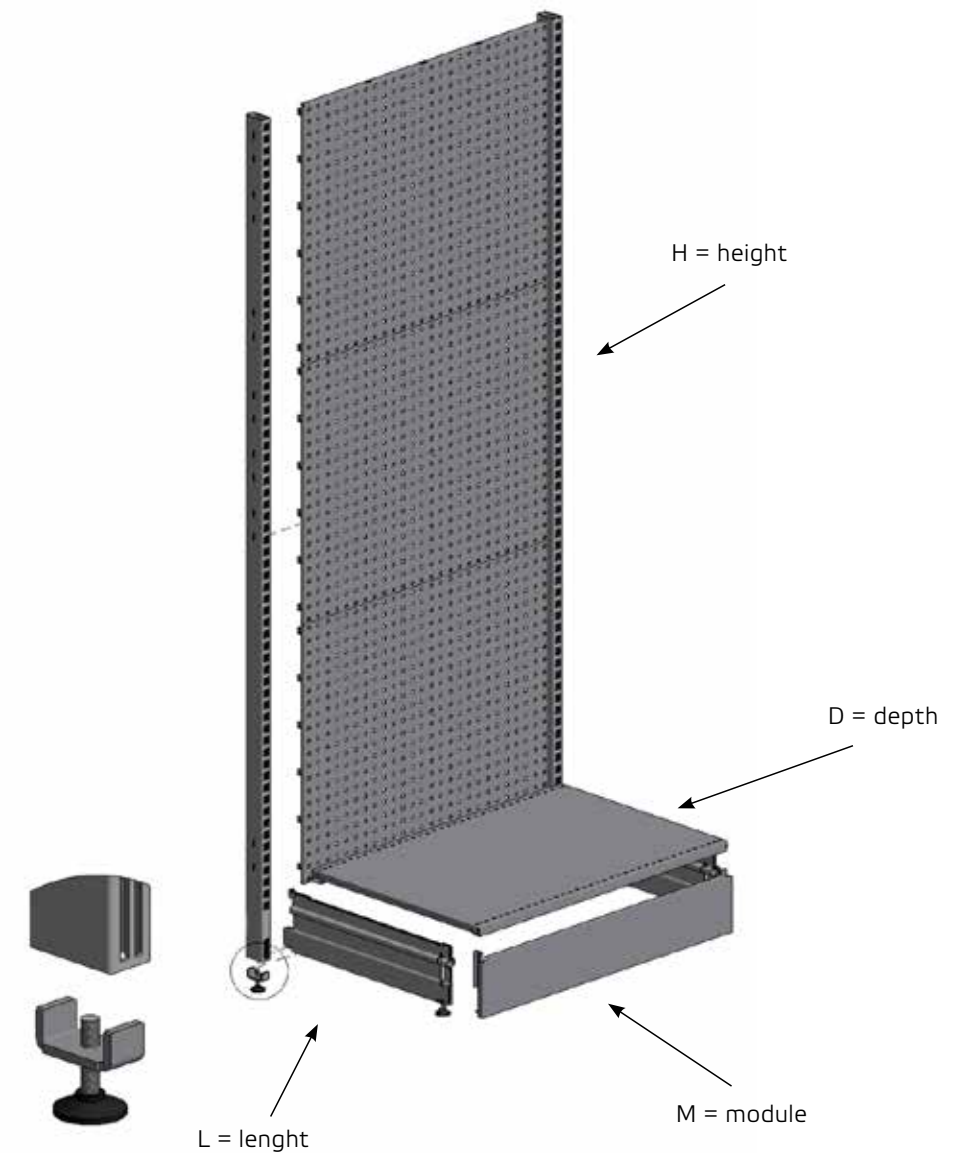

WALL SECTION START 50D

BSC2-6-180-5-13	180H	90M	50D
BSC2-6-212-5-13	212H	90M	50D
BSC2-6-228-5-13	228H	90M	50D
BSC2-6-235-5-13	235H	90M	50D
BSC2-6-267-5-13	267H	90M	50D
BSC2-6-299-5-13	299H	90M	50D

BSC2-6-180-5-136	180H	60M	50D
BSC2-6-212-5-136	212H	60M	50D
BSC2-6-228-5-136	228H	60M	50D
BSC2-6-235-5-136	235H	60M	50D
BSC2-6-267-5-136	267H	60M	50D
BSC2-6-299-5-136	299H	60M	50D

WALL SECTION START 60D

BSC2-6-180-5-03	180H	90M	60D
BSC2-6-212-5-03	212H	90M	60D
BSC2-6-228-5-03	228H	90M	60D
BSC2-6-235-5-03	235H	90M	60D
BSC2-6-267-5-03	267H	90M	60D
BSC2-6-299-5-03	299H	90M	60D

BSC2-6-180-5-036	180H	60M	60D
BSC2-6-212-5-036	212H	60M	60D
BSC2-6-228-5-036	228H	60M	60D
BSC2-6-235-5-036	235H	60M	60D
BSC2-6-267-5-036	267H	60M	60D
BSC2-6-299-5-036	299H	60M	60D



WALL SECTION FOLLOW 50D

BSC2-6-180-5-14	180H	90M	50D
BSC2-6-212-5-14	212H	90M	50D
BSC2-6-228-5-14	228H	90M	50D
BSC2-6-235-5-14	235H	90M	50D
BSC2-6-267-5-14	267H	90M	50D
BSC2-6-299-5-14	299H	90M	50D

BSC2-6-180-5-146	180H	60M	50D
BSC2-6-212-5-146	212H	60M	50D
BSC2-6-228-5-146	228H	60M	50D
BSC2-6-235-5-146	235H	60M	50D
BSC2-6-267-5-146	267H	60M	50D
BSC2-6-299-5-146	299H	60M	50D

WALL SECTION FOLLOW 60D

BSC2-6-180-5-04	180H	90M	60D
BSC2-6-212-5-04	212H	90M	60D
BSC2-6-228-5-04	228H	90M	60D
BSC2-6-235-5-04	235H	90M	60D
BSC2-6-267-5-04	267H	90M	60D
BSC2-6-299-5-04	299H	90M	60D

BSC2-6-180-5-046	180H	60M	60D
BSC2-6-212-5-046	212H	60M	60D
BSC2-6-228-5-046	228H	60M	60D
BSC2-6-235-5-046	235H	60M	60D
BSC2-6-267-5-046	267H	60M	60D
BSC2-6-299-5-046	299H	60M	60D

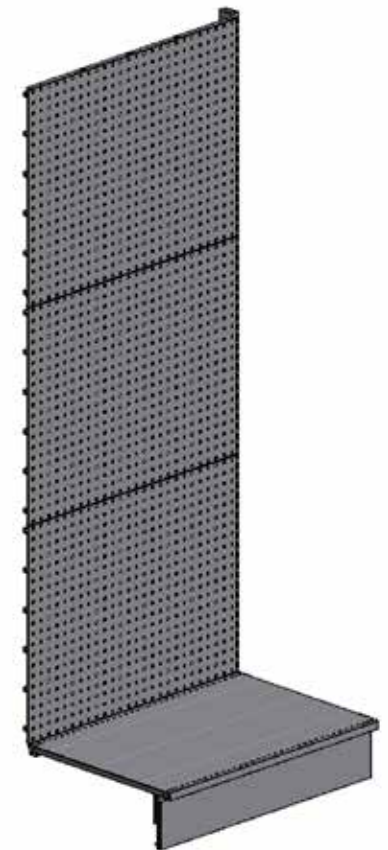

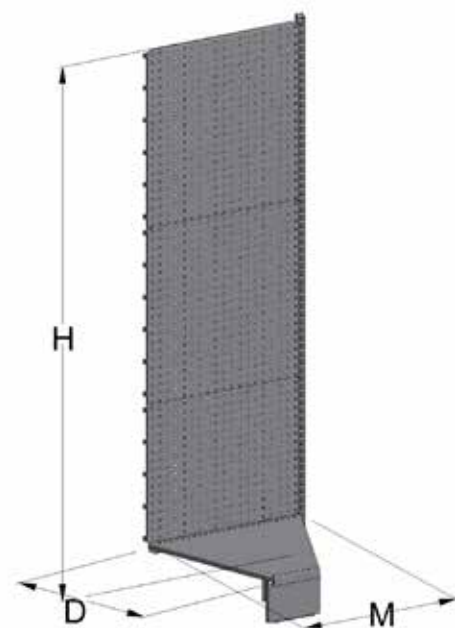
**WALL SECTION CORNER 50D**

BSC2-6-180-5-16	180H	90M	50D
BSC2-6-212-5-16	212H	90M	50D
BSC2-6-228-5-16	228H	90M	50D
BSC2-6-235-5-16	235H	90M	50D
BSC2-6-267-5-16	267H	90M	50D
BSC2-6-299-5-16	299H	90M	50D

WALL SECTION CORNER 60D

BSC2-6-180-5-06	180H	90M	60D
BSC2-6-212-5-06	212H	90M	60D
BSC2-6-228-5-06	228H	90M	60D
BSC2-6-235-5-06	235H	90M	60D
BSC2-6-267-5-06	267H	90M	60D
BSC2-6-299-5-06	299H	90M	60D

I COMPOSITIONS FLOOR

In the following chapter, you find the different compositions for floor and their product numbers.

FLOOR SOLUTION – PANEL PLANE

Intro for panel plane system

Wall and floor system with smooth steel backpanel. The backpanel closes off the background and is available in numerous colours, which contributes to supporting the expression and profile of the store. Can be installed with for eample hook rails and brackets for shelves mounting.

Facts:

- Available in numerous colours
- Mounted at the front of the column
- Can be installed with hook rails and brackets

The following examples are all based on a 60x30 upright.

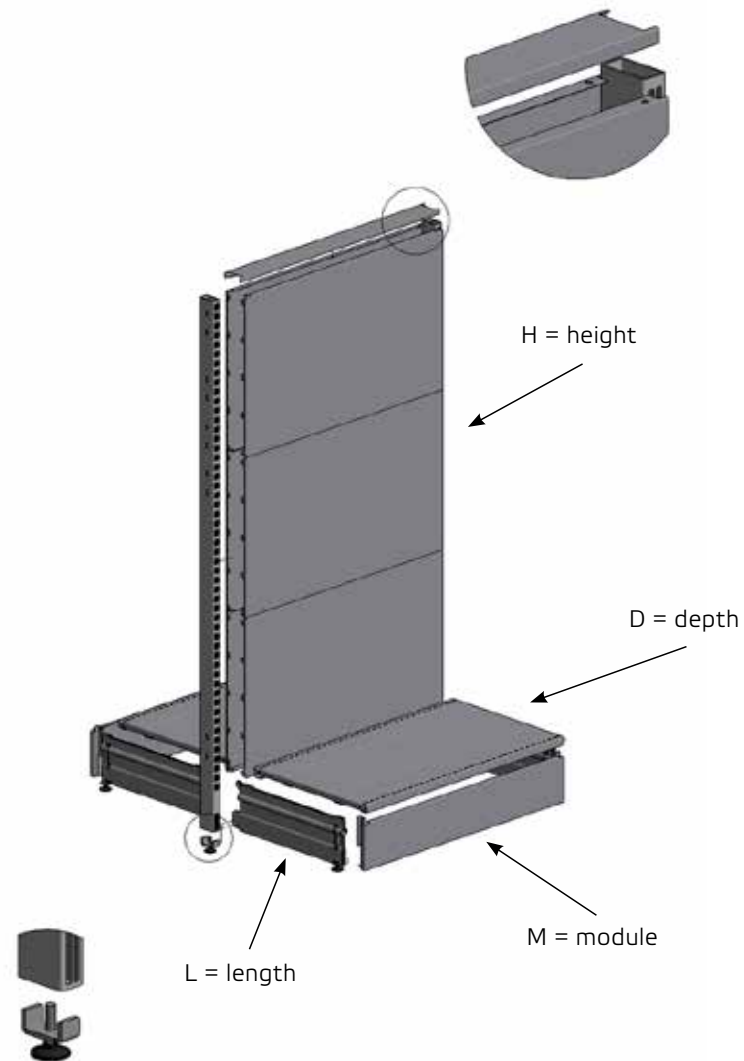

FLOOR SECTION START 50D

BSC2-6-126-2-11	126H	90M	50D
BSC2-6-142-2-11	142H	90M	50D
BSC2-6-158-2-11	158H	90M	50D
BSC2-6-180-2-11	180H	90M	50D

BSC2-6-126-2-116	126H	60M	50D
BSC2-6-142-2-116	142H	60M	50D
BSC2-6-158-2-116	158H	60M	50D
BSC2-6-180-2-116	180H	60M	50D

FLOOR SECTION START 60D

BSC2-6-126-2-01	126H	90M	60D
BSC2-6-142-2-01	142H	90M	60D
BSC2-6-158-2-01	158H	90M	60D
BSC2-6-180-2-01	180H	90M	60D

BSC2-6-126-2-116	126H	60M	60D
BSC2-6-142-2-116	142H	60M	60D
BSC2-6-158-2-116	158H	60M	60D
BSC2-6-180-2-116	180H	60M	60D

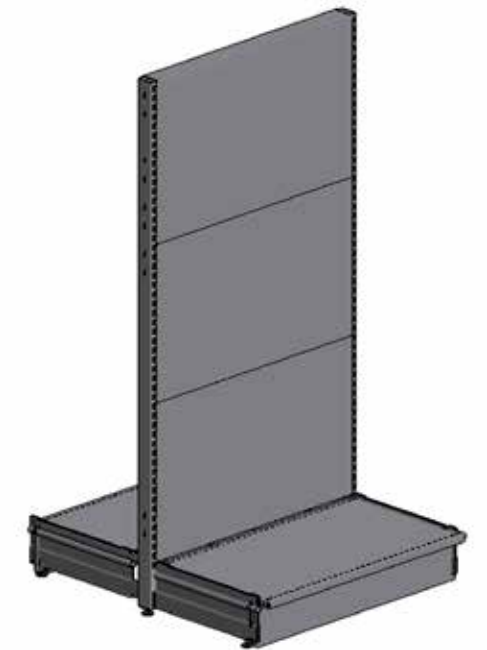

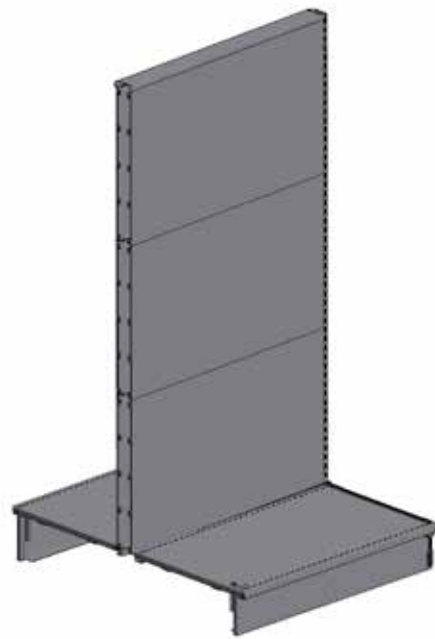

FLOOR SECTION FOLLOW 50D

BSC2-6-126-2-12	126H	90M	50D
BSC2-6-142-2-12	142H	90M	50D
BSC2-6-158-2-12	158H	90M	50D
BSC2-6-180-2-12	180H	90M	50D

BSC2-6-126-2-126	126H	60M	50D
BSC2-6-142-2-126	142H	60M	50D
BSC2-6-158-2-126	158H	60M	50D
BSC2-6-180-2-126	180H	60M	50D

FLOOR SECTION FOLLOW 60D

BSC2-6-126-2-02	126H	90M	60D
BSC2-6-142-2-02	142H	90M	60D
BSC2-6-158-2-02	158H	90M	60D
BSC2-6-180-2-02	180H	90M	60D

BSC2-6-126-2-026	126H	60M	60D
BSC2-6-142-2-026	142H	60M	60D
BSC2-6-158-2-026	158H	60M	60D
BSC2-6-180-2-026	180H	60M	60D

END FRAMES

BSC101-126	126H
BSC101-142	142H
BSC101-158	158H
BSC101-180	180H



FLOOR SOLUTION – PANEL PERFEX

Intro for panel perfex system

Wall and floor system with perforated backpanel provides a variety of options for mounting of hooks and sales-promoting products. The backpanel closes off the background and is available in numerous colours, which contributes to supporting the expression and profile of the store.

Facts:

- Optimal for mounting of hooks and sales promoting products
- Available in numerous colours
- Mounted at the front of the column

The following examples are based on a 60x30 upright.

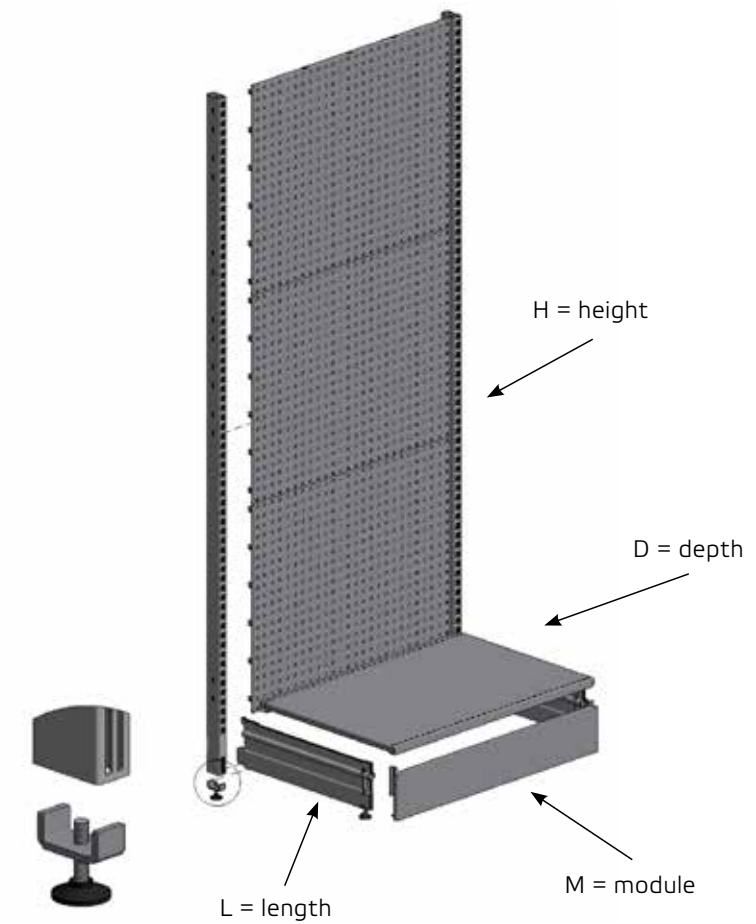

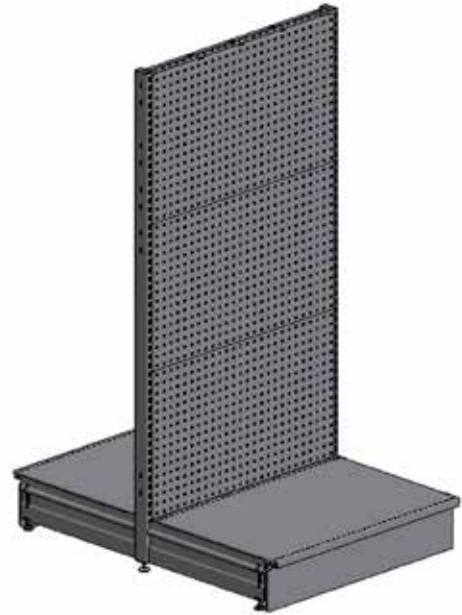

FLOOR SECTION START 50D

BSC2-6-126-5-11	126H	90M	50D
BSC2-6-142-5-11	142H	90M	50D
BSC2-6-158-5-11	158H	90M	50D
BSC2-6-180-5-11	180H	90M	50D

BSC2-6-126-5-116	126H	60M	50D
BSC2-6-142-5-116	142H	60M	50D
BSC2-6-158-5-116	158H	60M	50D
BSC2-6-180-5-116	180H	60M	50D

FLOOR SECTION START 60D

BSC2-6-126-5-01	126H	90M	60D
BSC2-6-142-5-01	142H	90M	60D
BSC2-6-158-5-01	158H	90M	60D
BSC2-6-180-5-01	180H	90M	60D

BSC2-6-126-5-016	126H	60M	60D
BSC2-6-142-5-016	142H	60M	60D
BSC2-6-158-5-016	158H	60M	60D
BSC2-6-180-5-016	180H	60M	60D

FLOOR SECTION FOLLOW 50D

BSC2-6-126-5-12	126H	90M	50D
BSC2-6-142-5-12	142H	90M	50D
BSC2-6-158-5-12	158H	90M	50D
BSC2-6-180-5-12	180H	90M	50D

BSC2-6-126-5-126	126H	60M	50D
BSC2-6-142-5-126	142H	60M	50D
BSC2-6-158-5-126	158H	60M	50D
BSC2-6-180-5-126	180H	60M	50D

FLOOR SECTION FOLLOW 60D

BSC2-6-126-5-02	126H	90M	60D
BSC2-6-142-5-02	142H	90M	60D
BSC2-6-158-5-02	158H	90M	60D
BSC2-6-180-5-02	180H	90M	60D

BSC2-6-126-5-026	126H	60M	60D
BSC2-6-142-5-026	142H	60M	60D
BSC2-6-158-5-026	158H	60M	60D
BSC2-6-180-5-026	180H	60M	60D

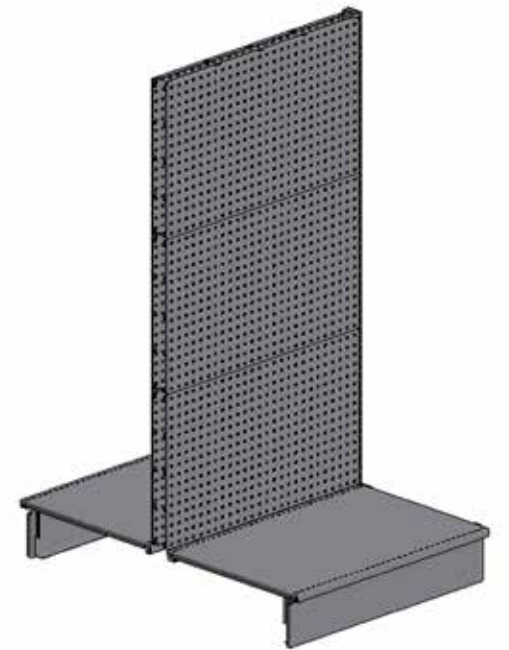

END FRAMES

BSC104-126	126H
BSC104-142	142H
BSC104-158	158H
BSC104-180	180H

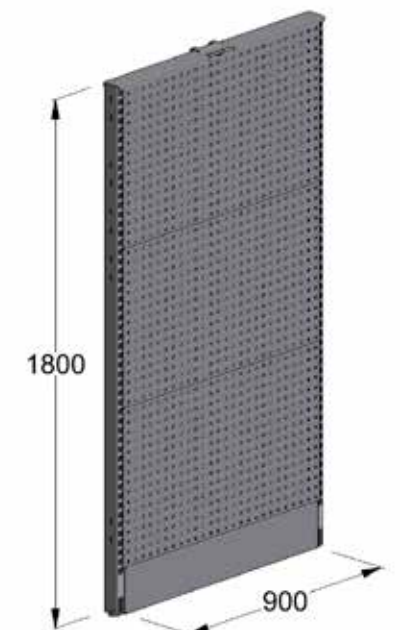

I WALL

For help and inspiration, you can on the following pages see examples of popular arrangements, and get to know which components they include.

WALL SECTION START 228H PLANE

BSC2-6-228-2-03

2 pcs.	054-6035-3	Upright 228H
2 pcs.	022-4020-4	Lock
2 pcs.	022-4003-3	Foot 56L
1 pcs.	014-6760-3	Sheet shelf 90M 60D
1 pcs.	022-4090-3	Plinth 90M
3 pcs.	019-7904-3	Panel plan 70H 90M
2 pcs.	012-7207-0	Locking clip

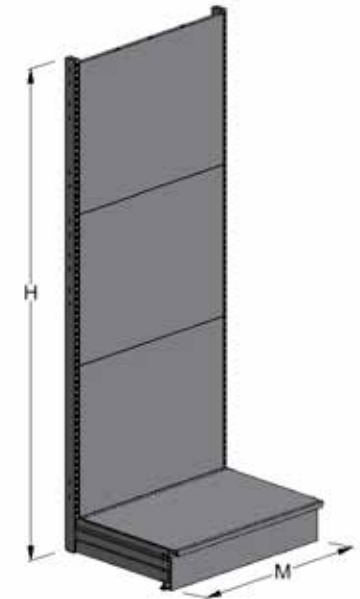

WALL SECTION FOLLOW 228H PLANE

BSC2-6-228-2-04

1 pcs.	054-6035-3	Upright 228H
1 pcs.	022-4020-4	Lock
1 pcs.	022-4003-3	Foot 56L
1 pcs.	014-6760-3	Sheet shelf 90M 60D
1 pcs.	022-4090-3	Plinth 90M
3 pcs.	019-7904-3	Panel plan 70H 90M
2 pcs.	012-7207-0	Locking clip

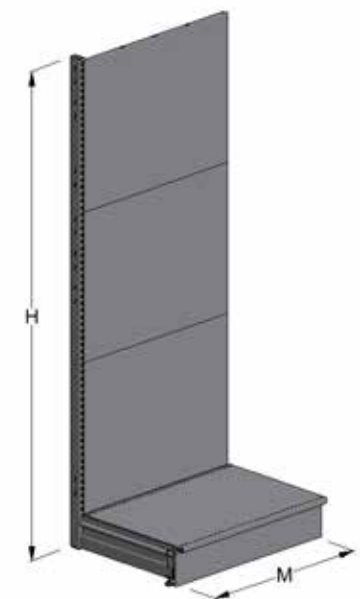

FLOOR SECTION START 142H PERFEX

BSC2-6-142-5-01

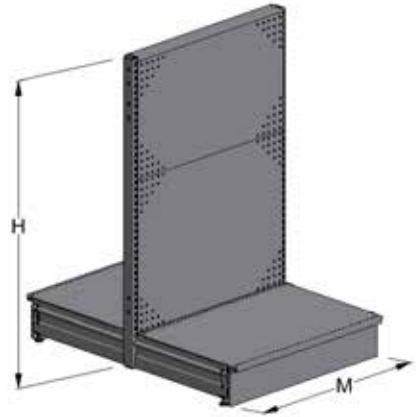

2 pcs.	054-6031-3	Upright 142H
2 pcs.	022-4020-4	Lock
4 pcs.	022-4003-3	Foot 56L
2 pcs.	014-6760-3	Sheet shelf 90M 60D
2 pcs.	022-4090-3	Plinth 90M
2 pcs.	025-5042-3	Panel perflex 54H 90M
2 pcs.	025-5024-3	Panel perflex 70H 90M
1 pcs.	015-1005-3	Top cover 90M
2 pcs.	012-7207-0	Locking clip

FLOOR SECTION FOLLOW 142H PERFEX

BSC2-6-142-5-02

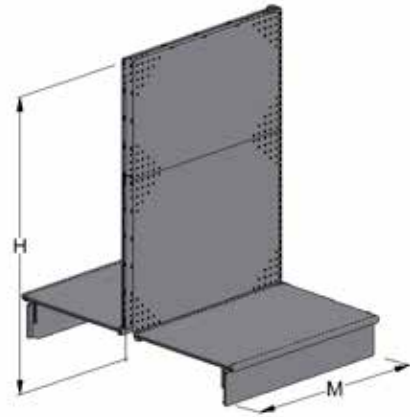

1 pcs.	054-6031-3	Upright 142H
1 pcs.	022-4020-4	Lock
2 pcs.	022-4003-3	Foot 56L
2 pcs.	014-6760-3	Sheet shelf 90M 60D
2 pcs.	022-4090-3	Plinth 90M
2 pcs.	025-5042-3	Panel perflex 54H 90M
2 pcs.	025-5024-3	Panel perflex 70H 90M
1 pcs.	015-1005-3	Top cover 90M
2 pcs.	012-7207-0	Locking clip

END FRAME 142H PERFEX/PLANE BACK PANELS

BSC104-142

1 pcs.	017-0027-3	End frame 142H
1 pcs.	025-5042-3	Panel perflex 54H 90M
1 pcs.	025-5024-3	Panel perflex 70H 90M
1 pcs.	019-7902-3	Panel plane 54H 90M
1 pcs.	019-7904-3	Panel plane 70H 90M
1 pcs.	015-1026-3	Top cover end frame 90M

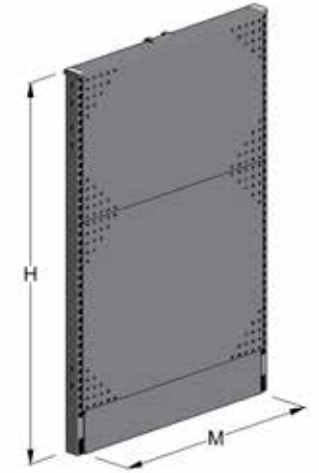

END FRAME 142H PERFEX/PLANE BACK PANELS

BSC2-6-228-2-06

1 pcs.	054-6035-3	Upright 228H
1 pcs.	022-4020-4	Lock
1 pcs.	022-4003-3	Foot 56L
1 pcs.	014-5246-3	Sheet shelf 0D
1 pcs.	022-9053-3	Plinth
3 pcs.	019-7701-3	Panel 70H

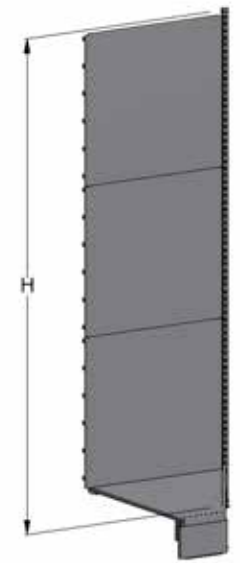

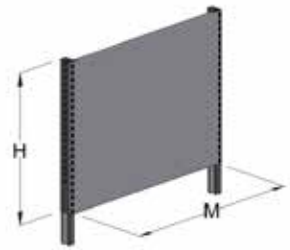

EXTENSION 163H WITH PLANE BACK PANELS

BSC111-1		
2 pcs.	054-2318-3	Extention 163H
3 pcs.	019-7902-3	Panel 54H
4 pcs.	012-7207-0	Back panel locking clip

FLOOR SECTION WITH WHEELS 158H WITH PLANE/PERFEX PANELS

BSC120		
3 pcs.	054-6032-3	Upright 158H
2 pcs.	017-0026-3	End frame
4 pcs.	014-6750-3	Sheet shelf 90M 50D
1 pcs.	007-2210-3	Bottom frame start 90M 50D
1 pcs.	007-2211-3	Bottom frame follow 90M 50D
2 pcs.	015-1005-3	Top cover
2 pcs.	015-1026-3	Top cover end
8 pcs.	025-5024-3	Panel perfex 70H 90M
4 pcs.	019-7904-3	Panel plan 70H 90M
12 pcs.	012-7207-0	Back panel locking clip

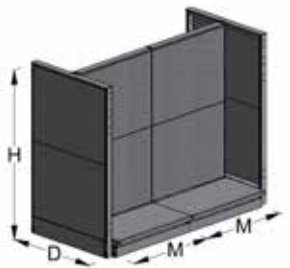

FLOOR SECTION

BSC119		
8 pcs.	054-6031-3	Upright 142H
8 pcs.	022-4020-4	Lock
8 pcs.	014-6760-3	Sheet shelf 90M 60D
16 pcs.	022-4003-3	Foot 56L
8 pcs.	022-4090-3	Plinth
8 pcs.	019-7902-3	Panel plane 54H 90M
8 pcs.	025-5024-3	Panel perfex 70H 90M
4 pcs.	015-1005-3	Top cover
16 pcs.	012-7207-0	Back panel locking clip

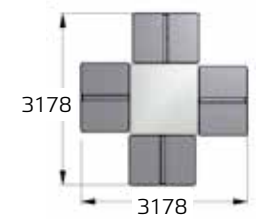
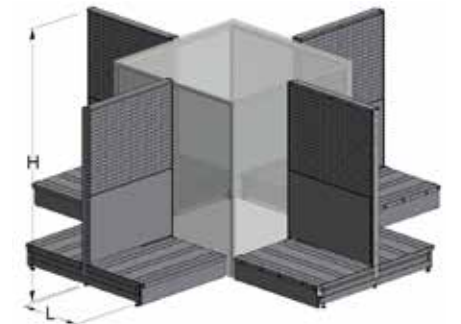

CORNER-SECTION, WALL 142H

BSC106		
4 pcs.	054-6031-3	Upright 142H
4 pcs.	022-4020-4	Lock
4 pcs.	014-5246-3	Sheet shelf 60D
2 pcs.	014-6760-3	Sheet shelf 60D
6 pcs.	022-4003-3	Foot 56L
4 pcs.	022-9053-3	Plinth
2 pcs.	022-4090-3	Plinth 90M
4 pcs.	019-7701-3	Panel plane 70H
4 pcs.	019-7700-3	Panel plane 54H
2 pcs.	019-7904-3	Panel plane 70H 90M
2 pcs.	019-7902-3	Panel plane 54H 90M
1 pcs.	015-1005-3	Top cover
1 pcs.	014-6881-3	Top cover B
1 pcs.	014-6880-3	Top cover A
1 pcs.	080-5379-0	Bracket double

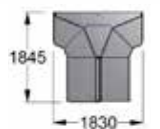
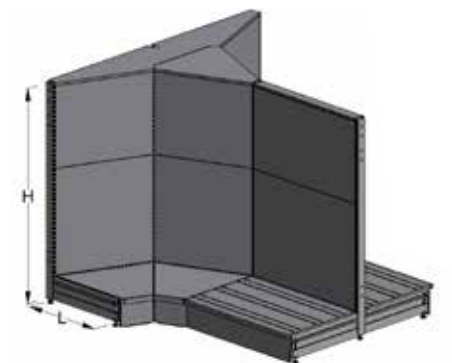

CORNER INTERNAL/EXTERIOR

BSC107

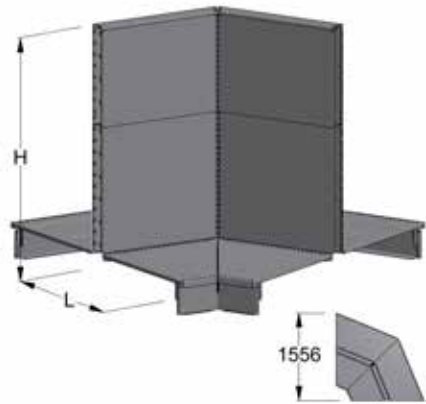

1 pcs.	054-6031-3	Upright 142H
1 pcs.	022-4020-4	Lock
2 pcs.	022-4003-3	Foot 56L
2 pcs.	014-5246-3	Sheet shelf 60D
2 pcs.	022-9053-3	Plinth
2 pcs.	019-7701-3	Panel plane 70H internal
2 pcs.	019-7700-3	Panel plane 54H internal
2 pcs.	019-7938-3	Panel plane 54H exterior
2 pcs.	019-7937-3	Panel plane 70H exterior
2 pcs.	022-9070-3	Plinth exterior
2 pcs.	014-5249-3	Sheet shelf exterior 60D
2 pcs.	022-5022-3	Top cover

INTERNAL CORNER 228H 60D 60X30 UPRIGHT

BSC122

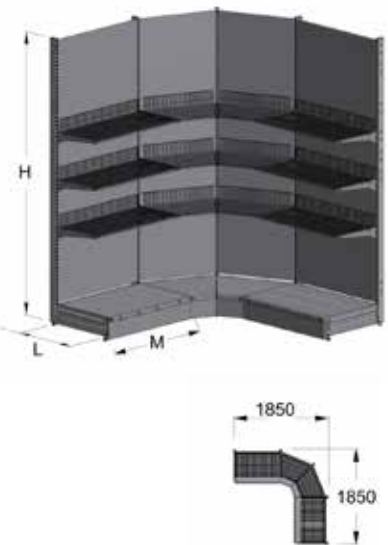

5 pcs.	054-6035-3	Upright 228H
5 pcs.	022-4020-4	Lock
5 pcs.	022-4003-3	Foot 56L
2 pcs.	014-6760-3	Sheet shelf 60D
6 pcs.	019-7701-3	Panel 70H 45 degrees 6x3
6 pcs.	019-7904-3	Panel plane 70H 90M
2 pcs.	022-4090-3	Plinth 90M
2 pcs.	022-9043-3	Plinth 45 degrees 90M 56L
2 pcs.	014-5246-3	Plinth 45 degrees 6X3
8 pcs.	012-7207-0	Back panel locking clip
4 pcs.	022-0300-3	Space bar for corner
6 pcs.	002-3045-3	Wireshelf 90M 45D
6 pcs.	001-7645-3	Wireshelf 45 degrees 45D 60x30
24 pcs.	021-2985-3	Bracket 45L

INTERNAL CORNER 228H 60D 80X30 UPRIGHT

BSC123

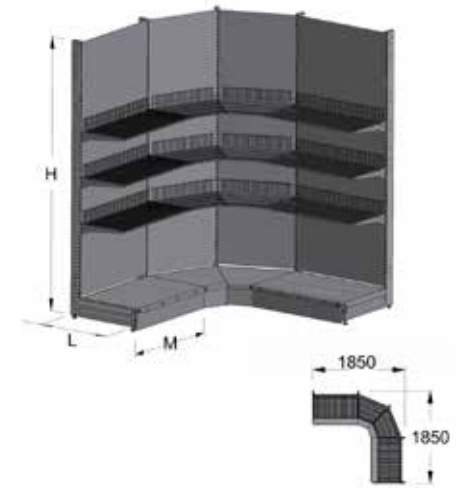

5 pcs.	054-8035-3	Upright 228H
5 pcs.	022-4040-4	Lock
5 pcs.	022-4003-3	Foot 56L
2 pcs.	014-6760-3	Sheet shelf 60D
6 pcs.	019-7741-3	Panel 70H 45 degrees 8x3
6 pcs.	019-7904-3	Panel plane 70H 90M
2 pcs.	022-4090-3	Plinth 90M
2 pcs.	022-9048-3	Plinth 45 degrees 90M 56L
2 pcs.	014-0403-3	Sheetshelf 45 degrees 8X3 60D
8 pcs.	012-7207-0	Back panel locking clip
4 pcs.	022-0300-3	Space bar for corner
6 pcs.	002-3045-3	Wireshelf 90M 45D
6 pcs.	001-7655-3	Wireshelf 45 degrees 45D 80x30
24 pcs.	021-2985-3	Bracket 45L

EXTERIOR CORNER 228H 60D 60X30 UPRIGHT

BSC124

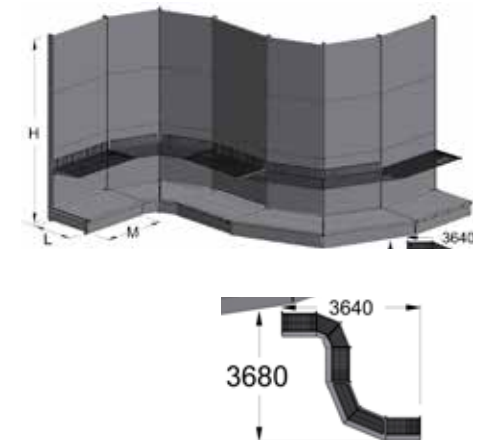

8 pcs.	054-6035-3	Upright 228H
8 pcs.	022-4020-4	Lock
8 pcs.	022-4003-3	Foot 56L
3 pcs.	014-6760-3	Sheet shelf 60D
6 pcs.	019-7701-3	Panel 70H 45 degrees 6x3
9 pcs.	019-7904-3	Panel plane 70H 90M
2 pcs.	014-5249-3	Sheet shelf ext. 6X3 60D
3 pcs.	022-4090-3	Plinth 90M
2 pcs.	022-9043-3	Plinth 45 degrees 90M 56L
2 pcs.	022-9070-3	Plinth ext. 6x3
2 pcs.	014-5246-3	Sheet shelf 45 degrees 6X3 60D
8 pcs.	012-7207-0	Back panel locking clip
4 pcs.	022-0300-3	Space bare for corner
6 pcs.	002-3045-3	Wireshelf 90M 45D
6 pcs.	001-7645-3	Wireshelf 45 degrees 45D 6x3
24 pcs.	021-2985-3	Bracket 45L
1 pcs.	001-8507-4	Wireshelf 45 degrees ext. 45D 6x3
6 pcs.	025-1080-3	Panel plane ext. 70H

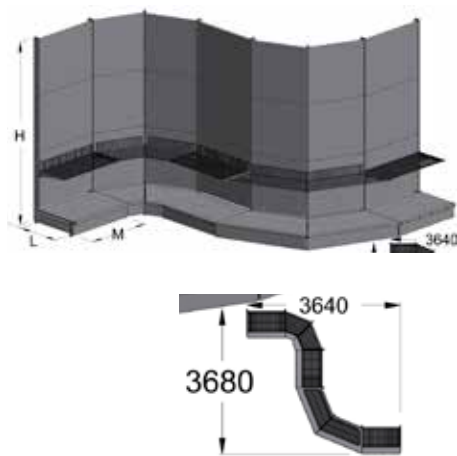
**EXTERIOR CORNER 228H 60D 80X30 UPRIGHT**

BSC125

8 pcs.	054-8035-3	Upright 228H
8 pcs.	022-4040-4	Lock
8 pcs.	022-4003-3	Foot 56L
3 pcs.	014-6760-3	Sheet shelf 60D
6 pcs.	019-7741-3	Panel 70H 45 degrees 8x3
9 pcs.	019-7904-3	Panel plane 70H 90M
2 pcs.	014-5252-3	Sheet shelf 45 degrees 8X3 60D
3 pcs.	022-4090-3	Plinth 90M
2 pcs.	022-1376-3	Plinth 45 degrees 90M 56L
2 pcs.	022-9072-3	Plinth ext. 8x3
2 pcs.	014-5265-3	Sheet shelf 45 degrees 8X3 60D
8 pcs.	012-7207-0	Back panel locking clip
4 pcs.	022-0300-3	Space bar for corner
6 pcs.	001-7655-3	Wireshef 90M 45D
6 pcs.	002-3100-3	Wireshef 45 degrees 45D 8x3
24 pcs.	021-2985-3	Bracket 45L
1 pcs.	002-3100-4	Wireshef 45 degree ext. 45D 8x3
6 pcs.	025-5124-3	Panel plane ext. 70H

COLOURS & MATERIALS

From our wide assortment of colours and materials you can choose exactly the option which suits your store environment. Here you find examples of standard colours, laminate and melamin surfaces. In addition to these standard colours and materials, we can also provide more options. Ask for more information.

Choosing the right colour and material for your store environment is important, our designers are ready to help you, so please contact us if you want our advice.



RAL-COLOURS

Our standard colours are mainly defined in RAL color system, others are mixed colours with structure – we have samples available, please ask us for further information and details if you have any special needs.

RAL colours are described by a four-digit number. RAL colour system is often used in connection with colour powder coating for surface treatment of metal.

See our Standard Colors on the next page.

ULTRAMARINE BLUE EXP. NO 05002 RAL 5002	TRAFFIC RED EXP. NO 03020 RAL 3020	DARK GREY EXP. NO 00510 RAL 7022	LIGHT GREY EXP. NO 07035 RAL 7035
BRILLIANT BLUE EXP. NO 00630 RAL 5007	FLAME RED EXP. NO 03000 RAL 3000	GREY BLACK EXP. NO 00432 RAL 7032	TELEGREY 1 EXP. NO 07045 RAL 7045
PASTEL BLUE EXP. NO 05024 RAL 5024	OXIDE RED EXP. NO 00633 RAL 3009	TRAFFIC GREY B EXP. NO 00585 RAL 7043	IRON GREY EXP. NO 07011 RAL 7011
AZURE BLUE EXP. NO 00631 RAL 5009	TRAFFIC ORANGE EXP. NO 02009 RAL 2009	DARK GREY EXP. NO 00555 RAL 7005	GREY EXP. NO 00391 RAL 7031
REED GREEN EXP. NO 06013 RAL 6013	BLUE WHITE EXP. NO 00032 RAL 9016	SLATE GREY EXP. NO 07015 RAL 7015	OYSTER WHITE EXP. NO 00592 RAL 1013
OLIVE GREEN EXP. NO 00635 RAL 6003	PURE WHITE EXP. NO 09010 RAL 9010	BASALT GREY EXP. NO 07012 RAL 7012	GREY BROWN EXP. NO 08019 RAL 8019
MOSS GREEN EXP. NO 00632 RAL 6005	SIGNAL WHITE EXP. NO 09003 RAL 9003	ANTHRACITE GREY EXP. NO 07016 RAL 7016	ALUMINUM SILVER EXP. NO 00381 RAL 9006
BOTTLE GREEN EXP. NO 00634 RAL 6007	SIGNAL WHITE – STRUCTURE EXP. NO 00511 RAL 9003	GRAPHITE GREY EXP. NO 07024 RAL 7024	WHITE ALUMINUM EXP. NO 00371 RAL 9006
RAPE YELLOW EXP. NO 01021 RAL 1021	SMOOTH MAT EXP. NO 00030 RAL 9005	TRAFFIC GREY EXP. NO 07042 RAL 7042	GREY ALUMINUM EXP. NO 00502 RAL 9007
ZINC YELLOW EXP. NO 00558 RAL 1018	JET BLACK EXP. NO 00144 RAL 9005	TELE GREY 4 EXP. NO 00570 RAL 7047	TACTILE ANTIGUE BRONZE EXP. NO 00467 RAL 8028

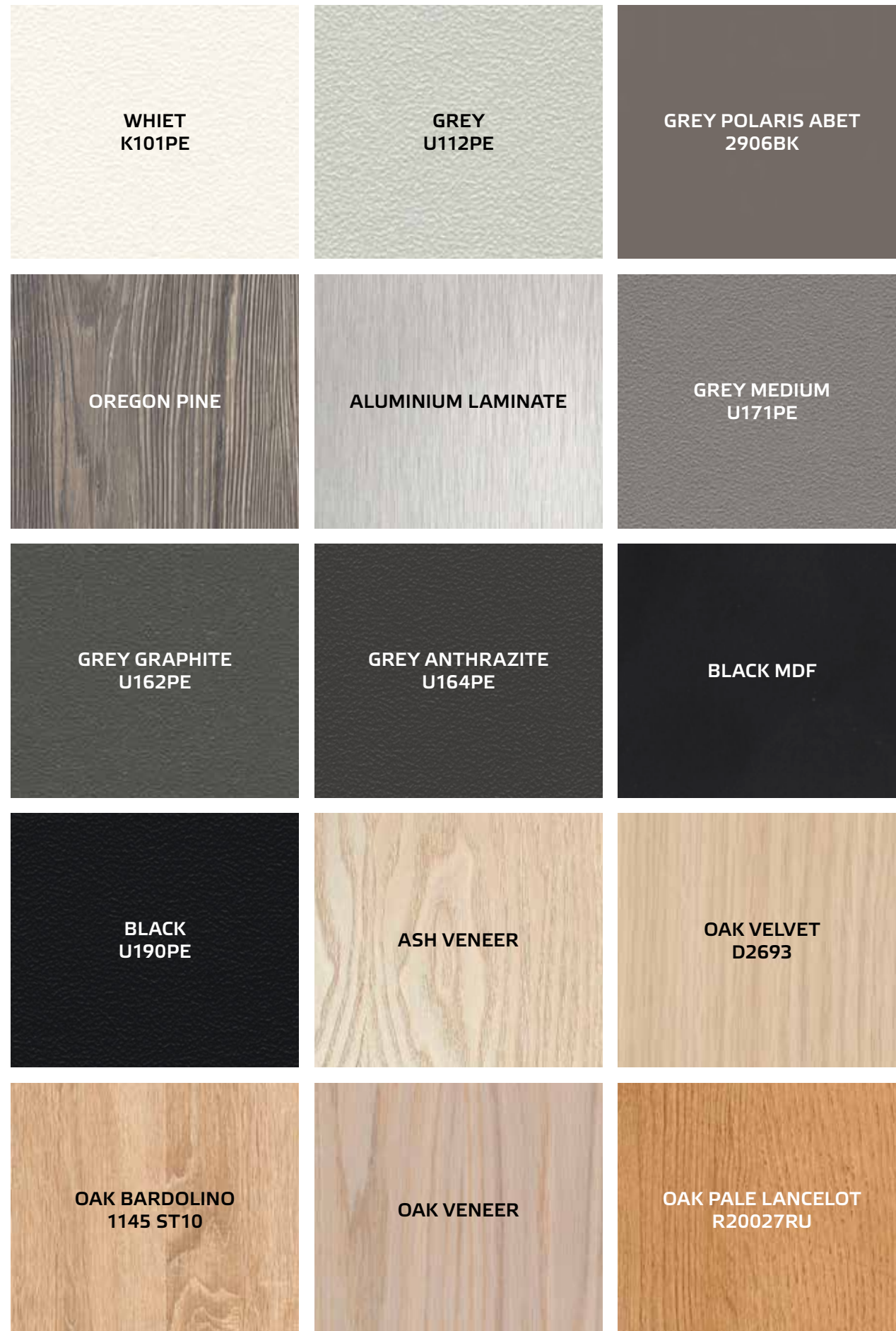

MELAMINES AND LAMINATES

The surface and finish you choose is decisive for how the shop appears. Our comprehensive selection of melamines and laminates gives you the possibility of finding exactly the right surfaces for your shop.

Melamine is a plastic material, which is pasted on chipboards to give them a colour on a certain surface. Melamine is the inexpensive alternative to laminate, and it works fine with most surfaces. It is not as hard-wearing as laminate, so it is typically used for vertical surfaces, but can also be used for shelves.

Laminate is the sturdy alternative to melamine. The base consists of many layers of paper which are glued together to give it durability. On top of

the paper layers is glued a thin film with a colour or structure and on the very top, a transparent wearing surface. Laminate is used for surfaces exposed to heavy wear conditions, such as counters.

Our materials specialists will gladly assist you in deciding which material to use in each individual case.

Contact Wanzl Nordic, and let us discuss which will be the right surface for your arrangement.

I INSTALLATION MANUALS LOAD SURVEY

INSTALLATION MANUAL – PANEL PLANE/PERFEX

3. For safety reasons, safety clips must be mounted correctly. Fit safety clips into the top slits (same slit in which the hook on the panel is fitted) on all uprights.

Note: When using metal back panels without space bars, the arrangement must always be secured by means of safety clips. Alternatively, the combination space bars/ metal back panels can be used.

See 088-4022-0 for fitting of space bars.

2. Fit back panels into slits at the front of the uprights.

4. Fit plinth into the slit of the side of the base leg.

1. Fit base leg on upright
Note: Base leg must be fitted before fitting of lock, which is fitted in the bottom of the upright.

5. Place shelf on the base leg.

LOAD SURVEY

LOAD SURVEY – CENTRAL ADJUSTER

Concerning wall section (1-sided load) and floor section (2-sided load) the below-mentioned is valid:

- The table values are valid for adjustable feed in joint and consecutive uprights
- The load has to be calculated according to the heaviest loaded section
- The load is evenly distributed
- Also on both sides of the floor section
- Wall section without wall brackets

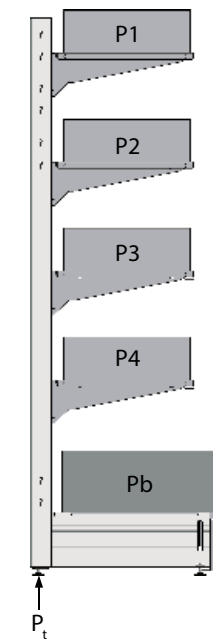

$$P_t = \frac{P_1 + P_2 + P_3 + P_4 + P_b}{2}$$

P = Load
P_t = Load on central adjuster

WALL SECTION

Foot	Max. load
60 X 30	550 KG
80 X 30	550 KG

$$P_t = (P_1 + P_3 + P_5 + P_7 + \frac{P_{b1}}{2}) + P_2 + P_4 + P_6 + P_8 + \frac{P_{b2}}{2}$$

P = Load
P_t = Load on central adjuster

FLOOR SECTION

Foot	Max. load
60 X 30	275 KG
80 X 30	275 KG

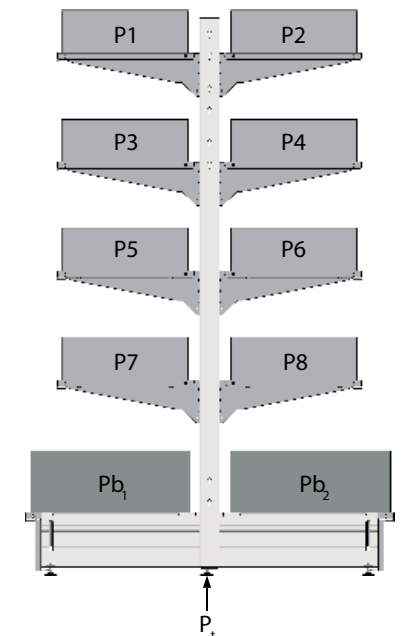

LOAD TABLE – BRACKETS

The table values are dependent on:

- Correct position of the brackets in slots
- Bracket and slot must be compatible
- Load is evenly distributed
- Load is static

Table values are stated in kg and make up maximum loads. The load is stated as load on shelves. Upon tilting of the adjustable type (KNE) the recommended load is reduced by about 50 per cent.

Length L	Max. load	
	Adjustable	Fast
20 cm	85 kg	180 kg
30 cm	75 kg	160 kg
40 cm	70 kg	140 kg
45 cm	60 kg	110 kg
50 cm	50 kg	80 kg
60 cm	40 kg	70 kg

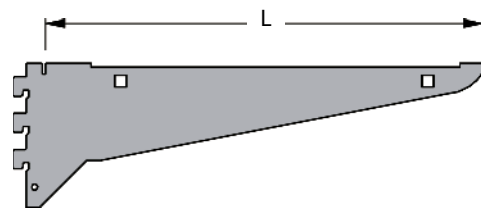
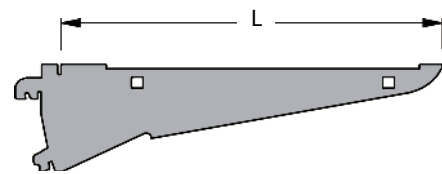

LOAD TABLE – WIRE SHELF AND SHEET METAL SHELF

The table values pre-suppose:

- Load is evenly distributed
- Shelves are chosen from Wanzl Nordics standard catalogue

Values are stated in kg and exclusively related to deflection of shelf.

$$\text{Deflection} = \frac{L}{200}$$

Thus the values are valid for both shelves used as bottom shelf or fixed foundation.

The values are not valid upon utilisation of shelf brackets/ consoles, since bracket/console can only carry limited loads. Refer to table for recommended loads on brackets.

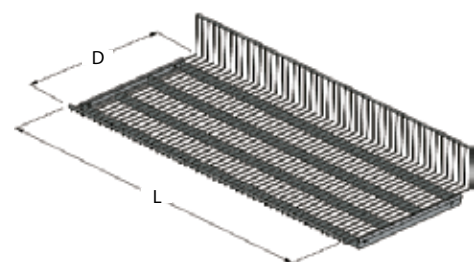

Depth D	Length L	
	60 cm	90 cm
20 cm		67 kg
25 cm	151 kg	67 kg
30 cm	151 kg	105 kg
35 cm	151 kg	105 kg
40 cm	304 kg	135 kg
45 cm	236 kg	135 kg
50 cm	304 kg	165 kg
60 cm	304 kg	203 kg

Depth D	Length L	
	60 cm	90 cm
20 cm	135 kg	65 kg
25 cm	475 kg	225 kg
30 cm	430 kg	195 kg
40 cm	645 kg	295 kg
50 cm*	575 kg	265 kg
60 cm*	575 kg	265 kg
70 cm**		405 kg
80 cm**	605 kg	290 kg

* We recommend the use of our fixed KNF bracket.
 ** Recommended only as bottom shelf.

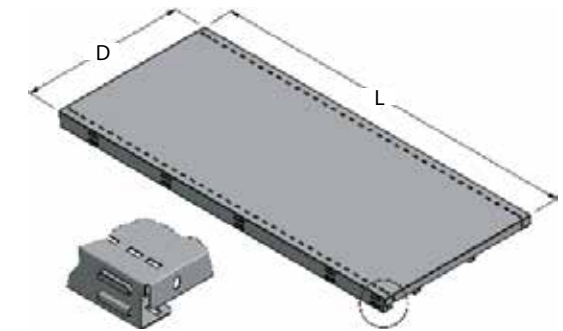

Depth D	Length L	
	60 cm	90 cm
20 cm		150 kg
30 cm	305 kg	160 kg
35 cm		180 kg
40 cm	595 kg	390 kg
45 cm		390 kg
50 cm	700 kg	430 kg
60 cm	700 kg	435 kg

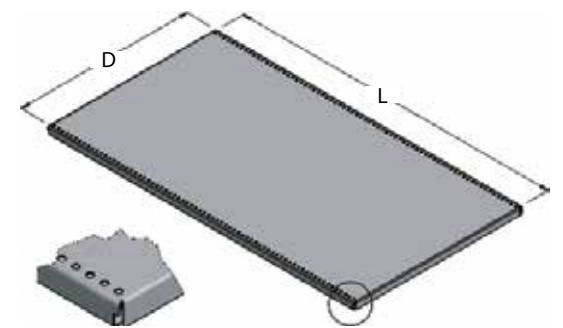

LOAD TABLE – MAX TORQUE

Table values are calculated including a safety factor of 1,5. Table values are calculated on the bases of upper limit values for deflection U_{max}

$$U_{max} = \frac{H}{50} = \frac{167}{50} = 3,4 \text{ cm} \quad H = \text{Height for } U_{max}$$

Calculation of total torque:

M_{shelf} is calculated for each shelf and accumulated to M_{total} Except from the bottom shelf.

Precondition:

- Load P is evenly distributed on the shelf
- Shelves are evenly distributed on the upright
- Max. height for top shelf is 167cm

When height for top shelf is $H_{measured} > 167 \text{ cm}$ the calculated value has to be corrected by factor K:

$$K = \frac{167}{H_{measured}}$$

Foot

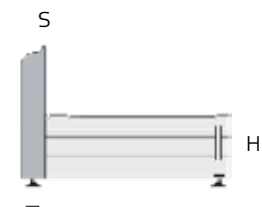

MAX. TORQUE (KGM) – UPRIGHT

60 x 30	80 x 30
53 kgm	112 kgm

D = shelf depth (m)
P = load (Kg)
M = torque (Kgm)

Ex. $M_{shelf} = P \times \frac{D}{2}$

Ex. $M_{total} = P_1 \times \frac{D_1}{2} + P_2 \times \frac{D_2}{2} + \dots + P_n \times \frac{D_n}{2}$

$M_{total} = M_1 + M_2 + M_3 + \dots + M_n$

When $H_{measured} > 167 \text{ cm}$ corrected by factor K

Ex. $M_{total} = \frac{M_1 + M_2 + M_3 + \dots + M_n}{K}$

$M_{total} \leq M_{tabel}$

Depth L	Max. load	
	Adjustable	Fast
20 cm	85 kg	180 kg
30 cm	75 kg	160 kg
40 cm	70 kg	140 kg
45 cm	60 kg	110 kg
50 cm	50 kg	80 kg
60 cm	40 kg	70 kg

PRE-CONDITIONS LOAD SURVEY

■ To ensure optimum and correct utilisation of equipment as well as to ensure the validity of the load-table's value, the below-mentioned requests have to be met.

When fitting

- Assembled and secured according to instruction for the individual product
- Mounted on an even and solid foundation having sufficient carrying ability
- Levelled horizontally and vertically
- T-upright having 3 pcs. standing feet to which the pressure is distributed evenly

When using

- Any load has to be evenly distributed on the entire load area
- Shelf brackets are hitched-on correctly and have to be identical in couples
- The equipment parts have to be compatible among them

Various

- Table values are not breaking values and have to be considered as guiding values for the recommended load
- Table values are thus not valid in case of point or push loads, but exclusively static load
- Table values are not valid in case of dynamic load, i.e. when driving, if the products are equipped with wheels
- Table values for upright deflection can be increased when using wall fittings, however, will be dependent on the nature of the wall and the fitting method
- On those products being not Wanzl Nordic products having load indications, the load values stated by the supplier are valid
- Wanzl Nordic reserves its right to changes in products and table values without notice.

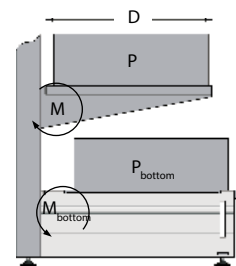



wanzl

VISIT US AT
www.wanzl.dk
www.wanzl.no
www.wanzl.se
www.wanzl.fi



DENMARK
Wanzl Nordic A/S
Toftegaardsvej 4
DK-8370 Hadsten

T: +45 87 612 200

info.dk@wanzl.com
www.wanzl.dk

NORWAY
Wanzl Nordic AS
Thorøyaveien 21
N-3209 Sandefjord

T: +47 33 423 280

info.no@wanzl.com
www.wanzl.no

SWEDEN
Wanzl Nordic AB
Dammvägen 1
S-571 75 Fredriksdal

T: +46 (0)10 - 47 61 700

info.se@wanzl.com
www.wanzl.se

FINLAND
Wanzl Nordic Oy
Tähtäinkuja 3
FI-01530 Vantaa

T: +358 20 741 4640

info.fi@wanzl.com
www.wanzl.fi

LATVIA
SIA Wanzl Nordic
Kapsēdes iela 2
LV-3414 Liepāja

T: +371 63 11 2717

info.lv@wanzl.com



The content of this catalog is indicative and reservations are made for typographical errors in the specification of dimensions, color, and material. Design and construction changes may occur. The shown inventory may be displayed with special equipment or in special materials. Contact us for further information. © Wanzl Nordic.