

Hotel highlights

Comprehensive solutions for the hotel industry





Wanzl Hotel Service

Intelligent and comprehensive solutions for the hotel industry

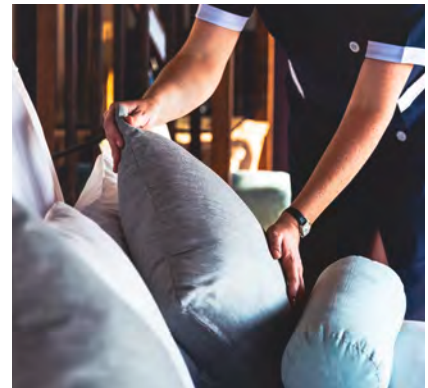

■ **For housekeeping, the lobby, restaurant, spa or in the back office:** As a comprehensive product and solution provider, Wanzl is the market leader for individual retail solutions and has been a reliable partner to the international hotel and cruise industry for decades with its Wanzl Hotel Service division.

■ **Its solutions bring together exceptional quality,** attractive aesthetics and distinctive, clean design, combined with optimum ergonomics. The extensive product range includes housekeeping trolleys, luggage and service trolleys as well as shelving solutions for storage rooms and the back office. Wanzl Hotel Service also offers extensive expertise and a flexible, proven modular system for creating hotel-owned mini-markets to meet individual customer requirements.

For optimised day-to-day hotel processes

■ **Wanzl's professional competence** ensures effective work processes in the hotel and catering trade – and thus also the competitiveness and business success of its partners. Functional, economical and user-friendly products minimise the effort required of personnel and help to satisfy the high expectations and requirements of guests.

Hotel highlights



Housekeeping trolleys



Wanzl: At home with housekeeping

■ **With its broad product portfolio, Wanzl** is now a key part of equipment landscape in the international hotel industry. The success story began with the Mundus housekeeping trolley. Today, the Tantum and Basic models complement the sustainable and high-quality range of housekeeping equipment. As a result, there is always the ideal model for every area and budget.

Renowned for its exceptional variability, the popular Mundus model offers almost endless possibilities for individual configuration. It also allows for flexible use of the trolley in different hotel areas, such as public areas or the hotel terrace.

The Tantum model impresses with its variable, adjustable wire shelves and robust design, while the Basic model impresses with its sturdy steel tube structure. Both models are just as durable as any other Wanzl product, despite the low level of investment required.

Mundus®

STORAGE RANGE

Ideal helper in two sizes

- > Ready for dispatch within 5 working days
- > Our classics in 2 sizes
- > For last-minute decisions and rush orders



MUNDUS 9 CLASSIC
04.08030.95-V329



MUNDUS 11 CLASSIC
04.08035.95-V160

Mundus 9 Classic

Finish: Anthracite grey

Frame colour: Metallic black

Structure: Aluminium structure

Left: Polyester bag

Right: Rubbish bag holder with cover

2 shelves: Anthracite grey

Mundus 11 Classic

Finish: Anthracite grey

Frame colour: Metallic black

Structure: Aluminium structure

Left: Polyester bag

Right: Rubbish bag holder with cover

2 shelves: Anthracite grey

■ Our decades of experience paired with elegant, timeless design – these classic trolleys are equipped to meet our customers' most common requirements.

Mundus®

Plenty of scope for customisation with fast delivery

**FAST DELIVERY
PROGRAMME**

- > Ready for dispatch within 15 working days
- > Custom combination with selected accessories
- > For those looking for a customised housekeeping trolley



SCAN THE QR CODE

■ **With the fast delivery programme**, you can now receive a new Mundus within a short space of time, and still have customisation options. Ready-assembled trolleys in four sizes are available and can be

supplemented with selected accessories and add-on parts according to personal requirements. An ideal solution for use in hotels, ships or similar facilities.

4 sizes

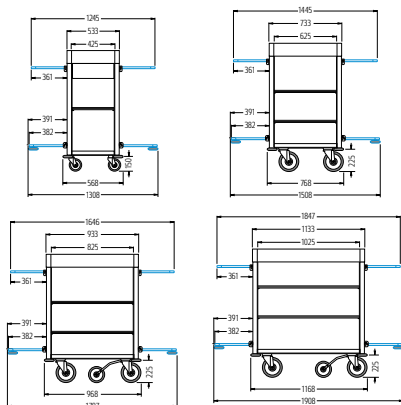

2 finishes

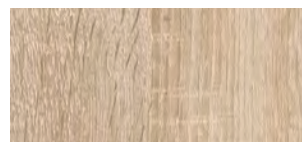

NATURAL OAK



ANTHRACITE

2 frame colours

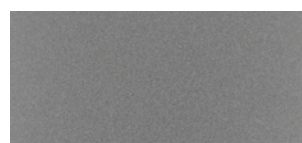

TITANIUM GREY



METALLIC BLACK

Laundry bag holder

Stable support for the matching laundry bag.



Rubbish bag holder

Fold-out bar for hanging a plastic bag, with folding leather cover for closing.



Cleaning tray holder

Transport cleaning materials safely with the cleaning tray holder.



Wire rack

Effective protection of your interior thanks to deflectors.



Fabric covering

Visually and functionally perfect with Velcro fastening. Colour: anthracite.



SmartFix mobile phone holder

For all conventional smartphones*: The lockable holder opens the door to digital housekeeping.

*Max. dimensions 160 x 78 mm



Basic

A housekeeping classic

THE TRIED-AND-TESTED CLASSIC

- > *Practical features*
- > *Protect your furniture with integrated deflectors*
- > *Platinum white finish*



BASIC

Platinum white finish

Illustration shows optional equipment

Effective protection

Non-marking deflectors on the frame and side sections protect against damage to the interior décor.

■ **The practical features of the basic housekeeping trolley** also offer the high Wanzl quality you have come to expect even for smaller budgets.

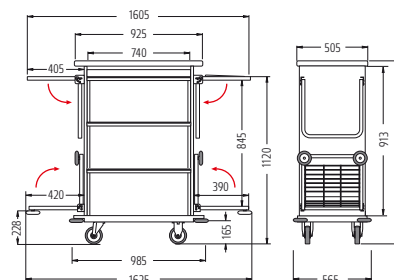

Dimensions (mm): Castor diameter 125
Load-bearing capacity:
Trolley shelves maximum 50 kg each
Trolley side parts maximum 20 kg each

Basic

Platinum white finish

Order no.

04.01240.95-0000

Tantum 9

Robust space saver at a low price

- > Variably adjustable wire shelves
- > Wooden rear panel as a privacy and dirt screen
- > Removable side panels for space-saving storage

**THE ECONOMIC
SPACE SAVER**



TANTUM 9

Frame in metallic black
Illustration shows optional equipment

■ In an international comparison, the **Tantum 9 house-keeping trolley** is the most economical. The model impresses with its lack of plastic parts. Its rear panel is made of hard-wearing, impact-resistant wood. It also serves as a screen and protection against dirt and, like the side panels and wire shelves, can be retrofitted if required.

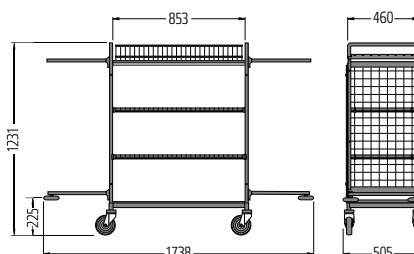

Dimensions (mm): Castor diameter 125
Load-bearing capacity:
Trolley shelves: maximum 50 kg each
Trolley side sections: maximum 20 kg each

Tantum 9

Plastic powder-coated in metallic black

Order no.

04.15708.95-7097

Mundus, Basic and Tantum accessories

Waste separation box

Simple waste separation: 2 boxes allow easy separation of different recyclable materials.



Mop holder 20–30 mm

The user-friendly, flexible holder system keeps everything under control.



Mundus utensils pocket

Accessories for even more space: For transporting additional utensils.



Small items box

For even better organisation: Clear arrangement of guest supplies. Made of wood, painted light pearl grey.

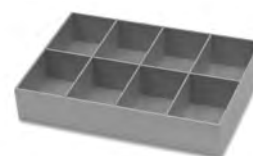

SmartFix mobile phone holder*

For all conventional smartphones: The lockable holder opens the door to digital housekeeping.

* Only for Basic and Mundus



Hotel highlights



Handcart



For a smooth laundry service with no risk of mix-ups

■ **Collection, transport and cleaning:** Handcarts from Wanzl make laundry services a great deal easier. The various models not only impress with their sturdy design, but also with their high manoeuvrability and space-saving folding mechanism. Various sizes cater to individual laundry volumes, as do a range of well-thought-out extras.

From the manoeuvrable trolley with up to three modules for narrow hotel corridors to the XXL model with an extra-large laundry bag, handcarts from Wanzl come equipped with everything you need for easy laundry transport as standard. Smart extras such as fabric bags in four different colours, polyester bags in different four sizes or practical hook and loop fasteners make laundry trolleys from Wanzl indispensable helpers for housekeeping.

Handcart SW KX

The agile model for hotels of every size

■ **A flexible laundry trolley for all situations.** The practical handcart, including a sturdy polyester bag, can be ordered in two sizes to suit individual requirements. Both sizes can be folded to save space.



SW 145 KX
With polyester bag and hook and loop fastener



SW 290 KX
With polyester bag and hook and loop fastener

SW 145 KX handcart Order no. 04.03843.95--7097
Basic frame with polyester bag and hook-and-loop fastener

SW 290 KX handcart Order no. 04.15934.95-7097
Basic frame with polyester bag and hook-and-loop fastener

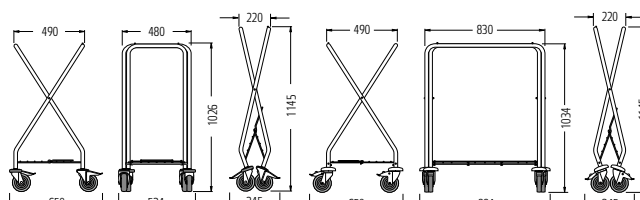

LT 240 handcart

XXL laundry service

■ **The XXL model with a volume** that saves personnel unnecessary footwork. Maximum benefit and simple handling make the LT 240 an essential and functional assistant for hectic everyday hotel work.

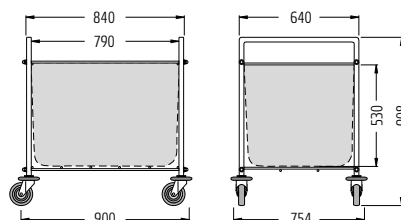

LT 240
handcart

LT 240 handcart

With 1 polyester bag as standard

Order no.

04.13900.95-7097

SW 80 handcart

Sorting laundry made easy

■ **Laundry pre-sorting** in the versions with 2 or 3 modules thanks to different coloured bags. These nifty trolleys make sure that all dirty laundry is correctly sorted for washing.

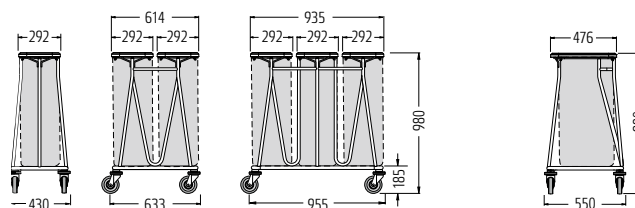

SW 1/80

SW 2/80

SW 3/80

SW 80 handcart

SW 1/80, for hanging 1 bag (bag not included)

SW 2/80 for hanging 2 bags (bags not included)

SW 3/80 for hanging 3 bags (bags not included)

Accessories (bags for initial and repeat orders)

1 fabric bag, 80 litres, red

1 fabric bag, 80 litres, blue

1 fabric bag, 80 litres, apricot

1 fabric bag, 80 litres, mint

1 polyester bag, 80 litres

Order no.

04.08928.75-7097

04.09041.75-7097

04.09154.75-7097

00.70540.00-0000

00.60935.00-0000

00.61613.00-0000

00.59692.00-0000

77.69618.00-0000

SW 3/80

fabric bags in blue, red and apricot

Hotel highlights



Helping hands in everyday hotel life



Equally at home in the back office as in the lobby

■ **Helping hands behind the scenes or stars in the hotel lobby:** As a comprehensive solution provider, Wanzl offers a large product portfolio for optimised processes in all hotel areas. From elegant luggage collection trolleys in reception to solutions for catering and room service, through to the ideal equipment for transport, hotel logistics and warehouse management.

The focus is always on effective workflows, sophisticated functionality, high standards of material and surface quality, as well as tasteful design. As such, clothes stands or room service tables are not only visible, they can also be stored in a space-saving manner. The shelved laundry trolleys and transport baskets also impress with their flexibility – in daily handling as well as in universal use.

GS-Lobby

The classic luggage collection trolley

- > *Modern design in black stainless steel*
- > *Attractive, durable carpet lining*
- > *Optional locking brake*



GS-LOBBY
Stainless steel, black

■ **For arriving guests, the luggage collection trolley contributes to the first impression.** This elegant design with high-grade surfaces and appealing, colourful carpet inlays will live up to the hotel's image.

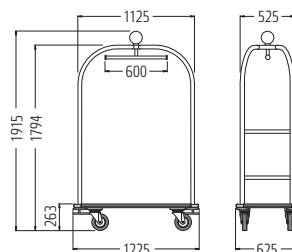

GS-Lobby luggage collection trolley

Order no.

Stainless steel, metallic black, grey melange carpet, with locking brake 04.14691.37-0000

GR Clothes stands

Pared-down design with unsurpassed function

- > *Can be nested to save space*
- > *Easy to move on castors*
- > *With practical hat rack*



GR
Clothes stands
Illustration shows
special equipment



GR
Nesting clothes stands

■ **A sleek outline that makes for an elegant feature** in any hotel environment. With a pared-down shape that can be nested to save space and is mounted on castors for maximum mobility. Two castor brakes ensure a secure position.

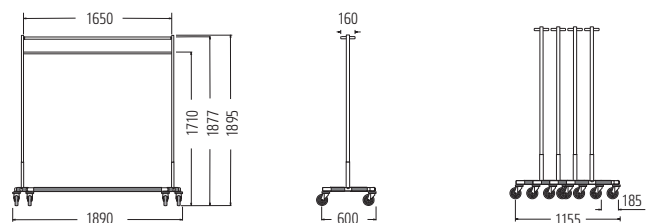

GR Clothes stands

With hat rack and 2 brakes

Order no.

04.02713.95-0001

Comfort room-service table

Dine in your room!

■ Ideally sized and stable side table

for hotel rooms or restaurants, folding sides for narrow passages. Also available on request with integrated hot box for keeping meals hot.



ROOM SERVICE TABLE



THE ROOM SERVICE TABLE can be folded together in just a few simple steps for transport in the elevator or for space-saving storage.



HOT BOX

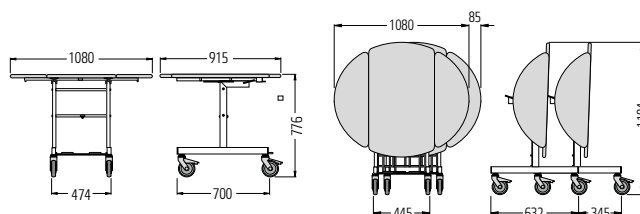

Can be nested to save space

With 3 shelves, the hot box is ideal for ensuring meals stay hot on their way to guest rooms. All connections on the back.

RSVC-Comfort room-service table

With fold-down side sections and 2 wire racks

Order no.

04.12883.95-0000

Accessories

Dimensions for 1 hot box (mm) W 410 x D 410 x H 530

Electric hot box, with 3 shelves, black

77.91379.09-0001

KT3 shelved laundry trolley

Transport trolley for clean laundry

■ **Easy handling thanks to flexible shelves and** two push handles.

Thanks to the fifth castor, the shelved laundry trolley is easy to manoeuvre and therefore ideally suited for hotel corridors.



KT3 SHELVED LAUNDRY TROLLEY
Illustration shows optional equipment

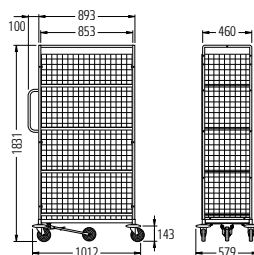

KT3 shelved laundry trolley
High-gloss galvanised, chrome-plated

Order no.
06.00231.50-V310

TK-R transport basket

Mobile transport basket

■ **Multi-purpose baskets** to meet all your needs, with robust design and profile all around to protect fixtures and fittings.



TK-R
Transport basket

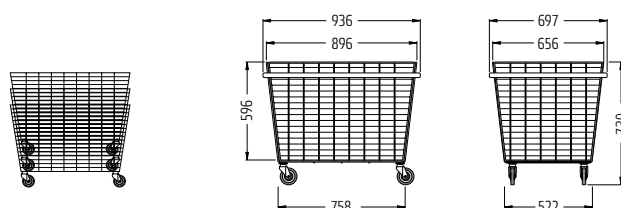

Transport baskets can be stacked to save space.

TK-R transport basket
With locking brake and impact protection

Order no.
05.31754.61-9010

Hotel highlights

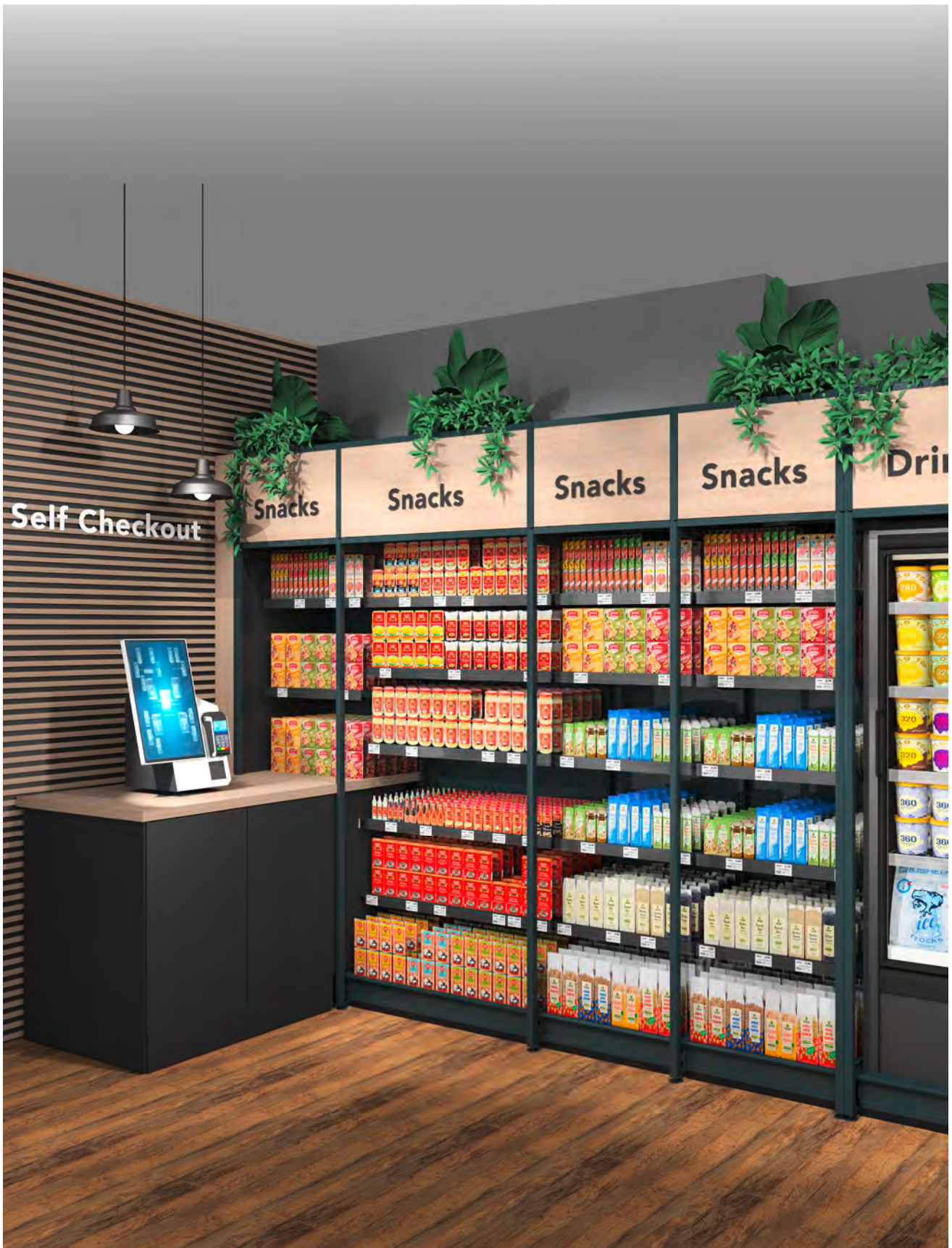

Mini-Market



Our shopping options for hotel guests

■ OUR SOLUTION

Mini-Markets – A 24/7 sales area for your hotel

Mini-markets meet the short-term needs of hotel guests, no matter what time of day or night. Opening hours up to 24/7 are possible, as are hybrid models (daytime with personnel, nighttime without).

Your benefits – at a glance

- Additional sales potential for hotels thanks to 100% revenue
- Guests can shop quickly and easily around the clock
- The range can be selected as desired and adapted to the hotel's target group; hotels are also able to sell their own items: snacks and beverages, health and beauty products, electronics
- The systematic modular design for the shop fittings enables modules to be added or changed at a later date
- Addressing all target groups: Leisure, crew, long stay, business travellers

FURTHER INFORMATION
SCAN THE QR CODE



Mini-market modules

Wanzl Mini-Markets

- > Comprehensive planning including interior design
- > Design your very own hotel shop
- > Optimal use of available space



Coffee station	Order no.
1250 x 600 x 2400 mm excl. coffee machine	04.16830.95-0001 04.16831.95-0001



Baked goods display	Order no.
1000 x 400 x 2400 mm with 3 wooden shelves	04.16386.95-0001



SCO module wire tech 100	Order no.
1000 x 600 x 2400 mm, incl. superstructure	04.16840.95-0001 04.16841.95-0001
SCO checkout terminal	98.78957.00-0000



Display gondola + gondola head	Order no.
1000 x 400 x 1600 mm each with 4 wire shelves	04.16380.95-7097

Mini-market modules

■ **To design your hotel shop** entirely according to your requirements, combine the following modules to create your personal 24/7 store.



Shelf conversion	Order no.
675 x 600 x 2000 mm for refrigerator or freezer	04.16387.95-7097

Product shelf	Order no.
1000 x 400 x 2400 mm, with 5 wire shelves incl. superstructure	04.16389.95-0001
625 x 400 x 2400 mm, with 5 wire shelves incl. superstructure	04.16388.95-0001



Genesis cash desk	Order no.
1218 x 552 x 901 mm SCO checkout terminal	13.09606.95-0001 98.78957.00-0000

YourTable T.01	Order no.
1265 x 865 x 750 mm with advertising board for attachment	04.16381.95-7097

YourTable T.02	Order no.
665 x 465 x 550 mm 665 x 465 x 750 mm	04.16382.95-7097 04.16383.95-7097

wanzl

VISIT US AT
www.wanzl.com



GERMANY

Wanzl GmbH & Co. KGaA

Rudolf-Wanzl-Straße 4

89340 Leipheim

Phone +49(0)82 21 / 7 29-0

hotel.de@wanzl.com

www.wanzl.com



Dimensions in mm, specifications approximate, colours similar to RAL, design subject to changes.
Illustrations may show optional equipment. © Wanzl GmbH & Co. KGaA 2024